



Energy Interoperation Version 1.0

Committee Specification Draft 01

26 November 2010

Specification URIs:

This Version:

<http://docs.oasis-open.org/energyinterop/ei/v1.0/csd01/energyinterop-v1.0-csd01.pdf>
<http://docs.oasis-open.org/energyinterop/ei/v1.0/csd01/energyinterop-v1.0-csd01.html>
<http://docs.oasis-open.org/energyinterop/ei/v1.0/csd01/energyinterop-v1.0-csd01.doc>
(Authoritative)

Previous Version:

N/A

Latest Version:

<http://docs.oasis-open.org/energyinterop/ei/v1.0/energyinterop-v1.0.pdf>
<http://docs.oasis-open.org/energyinterop/ei/v1.0/energyinterop-v1.0.html>
<http://docs.oasis-open.org/energyinterop/ei/v1.0/energyinterop-v1.0.doc>

Technical Committee:

OASIS Energy Interoperation TC

Chairs:

David Holmberg
William T. Cox

Editor:

Toby Considine

Related work:

This specification is related to:

- [EMIX V1.0](#)
- [WS-Calendar V1.0](#)
- NAESB Actors for DR

Declared XML Namespace(s):

<http://docs.oasis-open.org/ns/energyinterop>

Abstract:

Energy interoperation describes an information model and a communication model to enable collaborative and transactive use of energy, service definitions consistent with the OASIS SOA Reference Model, and XML vocabularies for the interoperable and standard exchange of:

- Dynamic price signals
- Reliability signals
- Emergency signals
- Communication of market participation information such as bids
- Load predictability and generation information

This work facilitates enterprise interaction with energy markets, which:

- Allows effective response to emergency and reliability events

- Allows taking advantage of lower energy costs by deferring or accelerating usage,
- Enables trading of curtailment and generation,
- Supports symmetry of interaction between providers and consumers of energy,
- Provides for aggregation of provision, curtailment, and use,

The definition of a price and of reliability information depends on the market context in which it exists. It is not in scope for this TC to define specifications for markets or for pricing models, but the TC will coordinate with others to ensure that commonly used market and pricing models are supported.

While this specification uses Web Services to describe the services, no requirement or expectation of specific messaging implementation is assumed.

Status:

This document was last revised or approved by the Energy Interoperation Technical Committee on the above date. The level of approval is also listed above. Check the “Latest Version” or “Latest Approved Version” location noted above for possible later revisions of this document.

Technical Committee members should send comments on this specification to the Technical Committee’s email list. Others should send comments to the Technical Committee by using the “Send A Comment” button on the Technical Committee’s web page at <http://www.oasis-open.org/committees/energyinterop/>.

For information on whether any patents have been disclosed that may be essential to implementing this specification, and any offers of patent licensing terms, please refer to the Intellectual Property Rights section of the Technical Committee web page (<http://www.oasis-open.org/committees/energyinterop/ipr.php>).

Citation Format:

When referencing this specification the following citation format should be used:

ENERGYINTEROP-v1.0 OASIS Committee Specification Draft 01, *Energy Interoperation Version 1.0*, November 2010. <http://docs.oasis-open.org/energyinterop/ei/v1.0/csd01/energyinterop-v1.0-csd01.doc>

Notices

Copyright © OASIS® 2010. All Rights Reserved.

All capitalized terms in the following text have the meanings assigned to them in the OASIS Intellectual Property Rights Policy (the "OASIS IPR Policy"). The full Policy may be found at the OASIS website.

This document and translations of it may be copied and furnished to others, and derivative works that comment on or otherwise explain it or assist in its implementation may be prepared, copied, published, and distributed, in whole or in part, without restriction of any kind, provided that the above copyright notice and this section are included on all such copies and derivative works. However, this document itself may not be modified in any way, including by removing the copyright notice or references to OASIS, except as needed for the purpose of developing any document or deliverable produced by an OASIS Technical Committee (in which case the rules applicable to copyrights, as set forth in the OASIS IPR Policy, must be followed) or as required to translate it into languages other than English.

The limited permissions granted above are perpetual and will not be revoked by OASIS or its successors or assigns.

This document and the information contained herein is provided on an "AS IS" basis and OASIS DISCLAIMS ALL WARRANTIES, EXPRESS OR IMPLIED, INCLUDING BUT NOT LIMITED TO ANY WARRANTY THAT THE USE OF THE INFORMATION HEREIN WILL NOT INFRINGE ANY OWNERSHIP RIGHTS OR ANY IMPLIED WARRANTIES OF MERCHANTABILITY OR FITNESS FOR A PARTICULAR PURPOSE.

OASIS requests that any OASIS Party or any other party that believes it has patent claims that would necessarily be infringed by implementations of this OASIS Committee Specification or OASIS Standard, to notify OASIS TC Administrator and provide an indication of its willingness to grant patent licenses to such patent claims in a manner consistent with the IPR Mode of the OASIS Technical Committee that produced this specification.

OASIS invites any party to contact the OASIS TC Administrator if it is aware of a claim of ownership of any patent claims that would necessarily be infringed by implementations of this specification by a patent holder that is not willing to provide a license to such patent claims in a manner consistent with the IPR Mode of the OASIS Technical Committee that produced this specification. OASIS may include such claims on its website, but disclaims any obligation to do so.

OASIS takes no position regarding the validity or scope of any intellectual property or other rights that might be claimed to pertain to the implementation or use of the technology described in this document or the extent to which any license under such rights might or might not be available; neither does it represent that it has made any effort to identify any such rights. Information on OASIS' procedures with respect to rights in any document or deliverable produced by an OASIS Technical Committee can be found on the OASIS website. Copies of claims of rights made available for publication and any assurances of licenses to be made available, or the result of an attempt made to obtain a general license or permission for the use of such proprietary rights by implementers or users of this OASIS Committee Specification or OASIS Standard, can be obtained from the OASIS TC Administrator. OASIS makes no representation that any information or list of intellectual property rights will at any time be complete, or that any claims in such list are, in fact, Essential Claims.

The names "OASIS" and "EnergyInterop" are trademarks of OASIS, the owner and developer of this specification, and should be used only to refer to the organization and its official outputs. OASIS welcomes reference to, and implementation and use of, specifications, while reserving the right to enforce its marks against misleading uses. Please see <http://www.oasis-open.org/who/trademark.php> for above guidance.

Table of Contents

1	Introduction	6
1.1	Terminology.....	7
1.2	Normative References.....	7
1.3	Non-Normative References	7
1.4	Contributions	8
1.5	Naming Conventions	9
1.6	Architectural References	10
2	Overview of Energy Interoperation.....	11
2.1	Scope of Energy Interoperation.....	11
2.2	Goals & Guidelines for Signals and Price and Product Communication.....	11
2.2.1	Specific scope statements.....	12
2.3	Background & Approach [Not Normative].....	12
2.4	Assumptions	13
2.4.1	Availability of Interval Metering.....	13
2.4.2	Use of EMIX	14
2.4.3	Use of WS-Calendar	14
2.4.4	Energy Services Interface	14
3	Energy Interoperation Architecture.....	15
3.1	Structure of Actors, Roles and Interactions	15
3.1.1	Transactive Roles and Interactions	15
3.1.2	Option Transaction Roles and Interactions	16
3.2	Demand Response and Resource Dispatch Interactions	17
3.2.1	Sample Interaction Patterns	18
3.2.2	Roles and Services	19
3.2.3	Services and Demand Response Interaction Patterns.....	20
4	Message Composition & Services.....	22
4.1	WS-Calendar in Energy Interop.....	22
4.1.1	Simple Sequences in WS-Calendar	22
4.2	EMIX and Energy Interop	23
4.3	Using Gluons to Define Contracts	24
4.4	Applying EMIX and WS-Calendar to a Power Event	25
4.5	Introduction to Services	25
5	Security and Composition [Non-Normative]	27
5.1	Security and Reliability Example	27
5.2	Composition.....	28
5.3	Energy Interoperation and Security	29
6	Energy Interoperation Services	30
7	Transactive Services.....	31
7.1.1	Information Model for the EiRegisterParty Service.....	31
7.1.2	Operation Payloads for the EiRegisterParty Service.....	32
7.2	Pre-Contract Services	32
7.2.1	Information Model for the EiTender and EiQuote Service	33
7.2.2	Operation Payloads for the EiTender Service	34

7.2.3	Operation Payloads for the EiQuote Service.....	35
7.3	Contract Management Services	35
7.3.1	Information Model for the EiContract Service.....	36
7.3.2	Operation Payloads for the EiContract Service	36
7.4	Post-Contract Services.....	37
7.4.1	Energy Usage Information.....	37
7.4.2	Full Requirements Verification	37
8	Event Services	38
8.1	EiEvent Service	38
8.1.1	Information Model for the EiEvent Service	38
8.1.2	Operation Payloads for the EiEvent Service	40
8.2	Feedback Service.....	41
8.2.1	Information Model for the EiFeedback Service.....	41
8.2.2	Operation Payloads for the EiFeedback Service.....	42
8.3	EiProgram Service.....	42
8.3.1	Information Model for the EiProgram Service.....	44
8.3.2	Operation Payloads for the EiProgram Service.....	45
9	Support Services.....	46
9.1	EiConstraint Service.....	46
9.1.1	Information Model for the Constraint Service	47
9.1.2	Operation Payloads for the EiConstraint Service	48
9.2	Opt Out Service.....	48
9.2.1	Information Model for the Opt Out Service	49
9.2.2	Operation Payloads for the Opt Out Service	50
9.3	Status Service	51
9.3.1	Information Model for the Status Service	51
9.3.2	Operation Payloads for the Status Service.....	51
10	Conformance.....	52
A.	Background and Development history	53
B.	Collaborative Energy.....	55
B.1	Collaborative Energy in Residences	55
B.2	Collaborative Energy in Commercial Buildings	55
B.3	Collaborative Energy in Industry	55
B.4	Summary of Collaborative Energy.....	56
C.	Glossary	57
D.	Acknowledgements	58
E.	Revision History	60

1 Introduction

Energy Interoperation defines information exchanges and services to coordinate energy supply and use, including power and ancillary services, between any two parties such as energy suppliers and customers, markets and service providers indicated below. Energy Interoperation makes no assumptions about which entities will enter those markets, or as to what those market roles will be called in the future. Energy Interoperation supports each of the arrows that represent communications, but is not limited to those interactions.

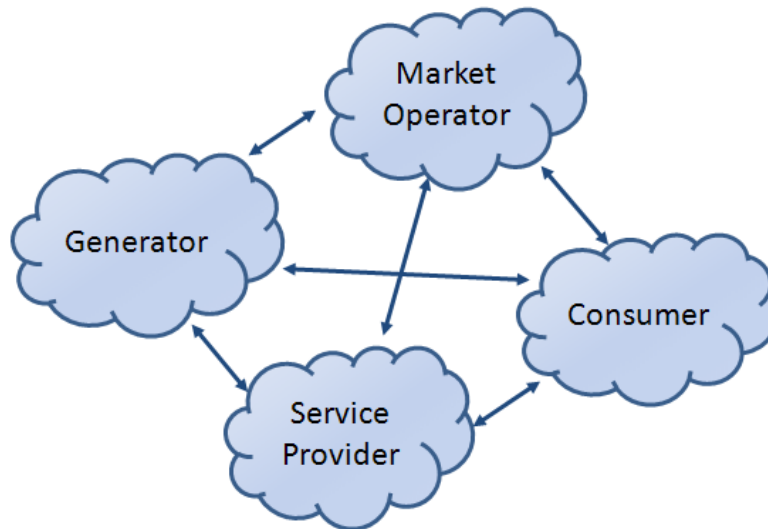

Figure 1-1: Representative Communications for Energy Interoperation

Energy Interoperation defines messages to communicate price, reliability, and emergency conditions. These communications can concern real time interactions, forward projections, or historical reporting. Energy Interoperation is intended to support market-based balancing of energy supply and demand while increasing fluidity of contracts. Increasing deployment of distributed and intermittent energy sources will require greater fluidity in both wholesale and retail markets. In retail markets, Energy Interoperation is meant to support greater consumer choice as to energy source.

Energy supplies are becoming more volatile due to the introduction of renewable energy sources. Energy supply margins are becoming smaller. The introduction of distributed energy resources may create localized surpluses and shortages. These changes will create more granular energy markets, more granular in temporal changes in price, and more granular in territory.

Balancing local energy resources brings more kinds of resources into the mix. Natural gas markets share many characteristics with electricity markets. Local thermal energy distribution systems can balance electricity markets while having their own surpluses and shortages. Nothing in Energy Interoperation restricts its use to electricity-based markets.

Energy consumers will need technologies to manage their local energy supply, including curtailment, storage, generation, and time-of-use load shaping and shifting. In particular, consumers will respond to Energy Interoperation messages for emergency and reliability events, or price messages to take advantage of lower energy costs by deferring or accelerating usage, and to trade curtailment, local generation and energy supply rights. Energy Interoperation does not specify which technologies consumers will use; rather it defines a technology agnostic interface to enable accelerated market development of such technologies.

To balance supply and demand, energy suppliers must be able to schedule resources, manage aggregation, and communicate both the scarcity and surplus of energy supply over time. Suppliers will use Energy Interoperation to inform customers of emergency and reliability events, to trade curtailment

34 and supply of energy, and to provide intermediation services including aggregation of provision,
35 curtailment, and use.

36 Energy Interoperation relies on standard format for communication time and interval [WS-Calendar] and
37 for Energy Price and Product Definition [EMIX]. This document assumes that there is a high degree of
38 symmetry of interaction at any Energy Interoperation interface, i.e., that providers and customers may
39 reverse roles during any period

40 The OASIS Energy Interoperation Technical Committee is developing this specification in support of the
41 National Institute of Standards and Technology (NIST) Framework and Roadmap for Smart Grid
42 Interoperability Standards, Release 1.0 [Framework] in support of the US Department of Energy (DOE) as
43 described in the Energy Independence and Security Act of 2007 [EISA2007].

44 Under the Framework and Roadmap, the North American Energy Standards Board (NAESB) surveyed
45 the electricity industry and prepared a consensus statement of requirements and vocabulary. This work
46 was submitted to the Energy Interoperation Committee in April 2010.

47 All examples and all Appendices are non-normative.

48 1.1 Terminology

49 The key words “MUST”, “MUST NOT”, “REQUIRED”, “SHALL”, “SHALL NOT”, “SHOULD”, “SHOULD
50 NOT”, “RECOMMENDED”, “MAY”, and “OPTIONAL” in this document are to be interpreted as described
51 in [RFC2119].

52 1.2 Normative References

- 53 **[RFC2119]** S. Bradner, *Key words for use in RFCs to Indicate Requirement Levels*,
54 <http://www.ietf.org/rfc/rfc2119.txt>, IETF RFC 2119, March 1997.
- 55 **[RFC2246]** T. Dierks, C. Allen *Transport Layer Security (TLS) Protocol Version 1.0*,
56 <http://www.ietf.org/rfc/rfc2246.txt>, IETF RFC 2246, January 1999.
- 57 **[SOA-RM]** OASIS Standard, *Reference Model for Service Oriented Architecture 1.0*,
58 October 2006. <http://docs.oasis-open.org/soa-rm/v1.0/soa-rm.pdf>
- 59 **[EMIX]** OASIS Committee Specification Draft 01, *Energy Market Information Exchange*
60 *1.0*, November 2010. [http://docs.oasis-open.org/emix/emix/v1.0/csd01/emix-v1.0-](http://docs.oasis-open.org/emix/emix/v1.0/csd01/emix-v1.0-csd01.pdf)
61 [csd01.pdf](http://docs.oasis-open.org/emix/emix/v1.0/csd01/emix-v1.0-csd01.pdf)
- 62 **[WS-Calendar]** OASIS Committee Specification Draft, *WS-Calendar 1.0*, September 2010.
63 [http://docs.oasis-open.org/ws-calendar/ws-calendar/v1.0/CD01/ws-calendar-1.0-](http://docs.oasis-open.org/ws-calendar/ws-calendar/v1.0/CD01/ws-calendar-1.0-spec-cd-01.pdf)
64 [spec-cd-01.pdf](http://docs.oasis-open.org/ws-calendar/ws-calendar/v1.0/CD01/ws-calendar-1.0-spec-cd-01.pdf)

65 1.3 Non-Normative References

- 66 **[OpenADR]** Mary Ann Piette, Girish Ghatikar, Sila Kiliccote, Ed Koch, Dan Hennage, Peter
67 Palensky, and Charles McParland. 2009. Open Automated Demand Response
68 Communications Specification (Version 1.0). California Energy Commission,
69 PIER Program. CEC-500-2009-063.
- 70 **[BACnet/WS]** Addendum C to ANSI/ASHRAE Standard 135-2004, *BACnet Web Services*
71 *Interface*.
- 72 **[ebXML-MS]** OASIS Standard, *Electronic Business XML (ebXML) Message Service*
73 *Specification v3.0: Part 1, Core Features*, October 2007. [http://docs.oasis-](http://docs.oasis-open.org/ebxml-msg/ebms/v3.0/core/os/ebms_core-3.0-spec-os.pdf)
74 [open.org/ebxml-msg/ebms/v3.0/core/os/ebms_core-3.0-spec-os.pdf](http://docs.oasis-open.org/ebxml-msg/ebms/v3.0/core/os/ebms_core-3.0-spec-os.pdf)
- 75 **[EISA2007]** Energy Independence and Security Act of 2007,
76 <http://nist.gov/smartgrid/upload/EISA-Energy-bill-110-140-TITLE-XIII.pdf>
- 77 **[Framework]** National Institute of Standards and Technology, *NIST Framework and Roadmap*
78 *for Smart Grid Interoperability Standards, Release 1.0*, January 2010,
79 http://nist.gov/public_affairs/releases/upload/smartgrid_interoperability_final.pdf

80	[Galvin]	Galvin Electricity Initiative, <i>Perfect Power</i> , http://www.galvinpower.org/perfect-power/what-is-perfect-power
81		
82	[ID-CLOUD]	OASIS Identity in the Cloud Technical Committee
83		http://www.oasis-open.org/committees/id-cloud
84	[KMIP]	OASIS Standard, <i>Key Management Interoperability Protocol Specification Version 1.0</i> , October 2010
85		
86		http://docs.oasis-open.org/kmip/spec/v1.0/kmip-spec-1.0.pdf
87	[SAML]	OASIS Standard, <i>Security Assertion Markup Language 2.0</i> , March 2005.
88		http://docs.oasis-open.org/security/saml/v2.0/saml-core-2.0-os.pdf
89	[OASIS SCA]	OASIS Service Component Architecture Member Section
90		http://www.oasis-open.org/sca
91	[OASIS PMRM]	OASIS Privacy Management Reference Model (PMRM) Technical Committee,
92		http://www.oasis-open.org/committees/pmrm
93	[SPML]	OASIS Standard, <i>Service Provisioning Markup Language (SPML) v2 - DSML v2 Profile</i> , April 2006. http://www.oasis-open.org/committees/download.php/17708/pstc-spml-2.0-os.zip
94		
95		
96	[SOA-RA]	OASIS Public Review Draft 01, <i>Reference Architecture for Service Oriented Architecture Version 1.0</i> , April 2008
97		
98		http://docs.oasis-open.org/soa-rm/soa-ra/v1.0/soa-ra-pr-01.pdf
99	[TEMIX]	OASIS Working Draft, <i>Transactional Energy White Paper</i> , May 2010.
100		http://www.oasis-open.org/committees/download.php/37954/TeMIX-20100523.pdf
101		
102	[WS-Addr]	Web Services Addressing (WS-Addressing) 1.0, W3C Recommendation,
103		http://www.w3.org/2005/08/addressing .
104	[WSFED]	OASIS Standard, <i>Web Services Federation Language (WS-Federation) Version 1.2</i> , 01 May 2009 http://docs.oasis-open.org/wsfed/federation/v1.2/os/ws-federation-1.2-spec-os.doc
105		
106		
107	[WSRM]	OASIS Standard, <i>WS-Reliable Messaging 1.1</i> , November 2004.
108		http://docs.oasis-open.org/wsrn/ws-reliability/v1.1/wsrn-ws_reliability-1.1-spec-os.pdf
109		
110	[WS-SecureConversation]	OASIS Standard, <i>WS-SecureConversation 1.3</i> , March 2007.
111		http://docs.oasis-open.org/ws-sx/ws-secureconversation/200512/ws-secureconversation-1.3-os.pdf
112		
113	[WS-Security]	OASIS Standard, <i>WS-Security 2004 1.1</i> , February 2006.
114		http://www.oasis-open.org/committees/download.php/16790/wss-v1.1-spec-os-SOAPMessageSecurity.pdf
115		
116	[WS-SX]	OASIS Web Services Secure Exchange (WS-SX) Technical Committee
117		http://www.oasis-open.org/committees/ws-sx
118	[XACML]	OASIS Standard, <i>eXtensible Access Control Markup Language 2.0</i> , February 2005. http://docs.oasis-open.org/xacml/2.0/access_control-xacml-2.0-core-spec-os.pdf
119		
120		

121 1.4 Contributions

122 The NIST Roadmap for Smart Grid Interoperability Standards described in the **[Framework]** requested
123 that many standards development organizations (SDOs) and trade associations work together closely in
124 unprecedented ways. An extraordinary number of groups came together and contributed effort, and time,
125 requirements, and documents. Each of these groups further gathered together, repeatedly, to review the
126 work products of this committee and submit detailed comments. These groups contributed large numbers
127 of documents to the Technical Committee. These efforts intersected with this specification in ways almost
128 impossible to unravel, and the committee acknowledges the invaluable works below which are essential
129 to understanding the North American Grid and its operation today, as well as its potential futures.

- 130 **NAESB Smart Grid Standards Development Subcommittee:**
 131 The following documents are password protected. For information about obtaining access to
 132 these documents, please visit www.naesb.org or contact the NAESB office at (713) 356 0060.
- 133 **[NAESB EUI]** NAESB REQ Energy Usage Information Model:
 134 [http://www.naesb.org/member_login_check.asp?doc=req_rat102910_req_2010_](http://www.naesb.org/member_login_check.asp?doc=req_rat102910_req_2010_ap_9d_rec.doc)
 135 [ap_9d_rec.doc](http://www.naesb.org/member_login_check.asp?doc=req_rat102910_req_2010_ap_9d_rec.doc)
- 136 **[NAESB EUI]** NAESB WEQ Energy Usage Information Model:
 137 [http://www.naesb.org/member_login_check.asp?doc=weq_rat102910_weq_2010_](http://www.naesb.org/member_login_check.asp?doc=weq_rat102910_weq_2010_ap_6d_rec.doc)
 138 [ap_6d_rec.doc](http://www.naesb.org/member_login_check.asp?doc=weq_rat102910_weq_2010_ap_6d_rec.doc)

139 The following documents are under development and subject to change.

- 140 **[NAESB PAP 09]** Phase Two Requirements Specification for Wholesale Standard DR Signals – for
 141 NIST PAP09:
 142 http://www.naesb.org/pdf4/weq_2010_ap_6c_rec_101510_clean.doc
- 143 **[NAESB PAP 09]** Phase Two Requirements Specification for Retail Standard DR Signals – for
 144 NIST PAP09: http://www.naesb.org/pdf4/retail_2010_ap_9c_rec_101510.doc

145 **The ISO / RTO Council Smart Grid Standards Project:**

- 146 **Information Model – HTML:** http://www.isorto.org/atf/cf/%7B5B4E85C6-7EAC-40A0-8DC3-003829518EBD%7D/IRC-DR-InformationModel-HTML-Condensed_Rev1_20101014.zip
- 147
 148
- 149 **Information Model – EAP:** http://www.isorto.org/atf/cf/%7B5B4E85C6-7EAC-40A0-8DC3-003829518EBD%7D/IRC-DR-InformationModel-EAP-Condensed_Rev1_20101014.zip
- 150
 151
- 152 **XML Schemas:** http://www.isorto.org/atf/cf/%7B5B4E85C6-7EAC-40A0-8DC3-003829518EBD%7D/IRC-DR-XML_Schemas_Rev1_20101014.zip
- 153
- 154 **Eclipse CIMTool Project:** http://www.isorto.org/atf/cf/%7B5B4E85C6-7EAC-40A0-8DC3-003829518EBD%7D/IRC-DR-CIMTool-Project-Workspace_Rev1_20101014.zip
- 155
- 156 **Interactions - Enrollment and Qualification:** http://www.isorto.org/atf/cf/%7B5B4E85C6-7EAC-40A0-8DC3-003829518EBD%7D/IRC-DR-Interactions-HTML_Enrollment_And_Qualification_Rev1_20101014.zip
- 157
 158
- 159 **Interactions - Scheduling and Award Notification:** http://www.isorto.org/atf/cf/%7B5B4E85C6-7EAC-40A0-8DC3-003829518EBD%7D/IRC-DR-Interactions-HTML_Scheduling_And_Award_Notification_Rev1_20101014.zip
- 160
 161
- 162 **Interactions - Deployment and Real Time Notifications:**
 163 http://www.isorto.org/atf/cf/%7B5B4E85C6-7EAC-40A0-8DC3-003829518EBD%7D/IRC-DR-Interactions-HTML_Deployment_And_RealTime_Communications_Rev1_20101014.zip
- 164
 165
- 166 **Interactions - Measurement and Performance:** http://www.isorto.org/atf/cf/%7B5B4E85C6-7EAC-40A0-8DC3-003829518EBD%7D/IRC-DR-Interactions-HTML_Measurement_And_Performance_Rev1_20101014.zip
- 167
 168
- 169 **Interactions Non-Functional Requirements:** http://www.isorto.org/atf/cf/%7B5B4E85C6-7EAC-40A0-8DC3-003829518EBD%7D/IRC-DR-Non-Functional_Requirements_Rev1_20100930.pdf
- 170
 171

172 **UCAIug OpenSG OpenADR Task Force:**

173 Need definitive and permanent links here

174 **1.5 Naming Conventions**

175 This specification follows some naming conventions for artifacts defined by the specification, as follows:

176 For the names of elements and the names of attributes within XSD files, the names follow the
 177 lowerCamelCase convention, with all names starting with a lower case letter. For example,

178

```
<element name="componentType" type="energyinterop:type-componentType"/>
```

179 For the names of intents, the names follow the UpperCamelCase convention, with all names starting with
180 an upper case letter, EXCEPT for cases where the intent represents an established acronym, in which
181 case the entire name is in upper case.
182 An example of an intent that is an acronym is the "SOAP" intent.

183 1.6 Architectural References

184 Energy Interoperability defines a service-oriented approach to energy interactions. Accordingly, it
185 assumes a certain amount of definitions of roles, names, and interaction patterns. This document relies
186 heavily on roles and interactions as defined in the OASIS Standard *Reference Model for Service Oriented*
187 *Architecture*.

188 Service orientation refers to an integration approach that focuses on the desired results rather than the
189 requested processes **[SOA-RA]**. Service orientation complements loose integration. Service orientation
190 organizes distributed capabilities that may be in different ownership domains.

191 Visibility, interaction, and effect are key concepts for describing the SOA paradigm. Visibility refers to the
192 capacity for those with needs and those with capabilities to be able to see each other. Interaction is the
193 activity of using a capability. A service provides a decision point for any policies and contracts without
194 delving into the process on either side of the interface

195 Services are concerned with the public actions of each interoperating system. Private actions, e.g., those
196 on either side of the interface, are considered inherently unknowable by other parties. A service can be
197 used without needing to know all the details of its implementation. Services are generally paid for results,
198 not effort.

199 2 Overview of Energy Interoperation

200 2.1 Scope of Energy Interoperation

201 Energy Interoperation (EI) supports transactive energy [TEMIX]. EI also supports demand response
202 approaches ranging from limited direct load control to override-able suggestions to customers. EI includes
203 measurement and verification of curtailment. EI engages Distributed Energy Resources (DER) while
204 making no assumptions as to their processes or technology.

205 While this specification supports agreements and contractual obligations, this specification offers flexibility
206 of implementation to support specific programs, regional requirements, and goals of the various
207 participants including the utility industry, aggregators, suppliers, and device manufacturers.

208 It is not the intent of the Energy Interoperation Technical Committee to imply that any particular
209 contractual obligations are endorsed, proposed, or required in order to implement this specification.
210 Energy market operations are beyond the scope of this specification although the interactions that enable
211 management of the actual delivery and acceptance are within scope. Energy Interoperation defines
212 interfaces for use throughout the transport chain of electricity as well as supporting today's intermediation
213 services and those that may arise tomorrow.

214 2.2 Goals & Guidelines for Signals and Price and Product 215 Communication

- 216 1. There are at least four market types, and signals and price and product standardization must
217 support all four, while allowing for the key differences that exist and will continue to exist in them.
218 The four market types are:
 - 219 • no open wholesale and no retail competition
 - 220 • open wholesale market only
 - 221 • open retail competition only
 - 222 • open wholesale and open retail competition.
- 223 2. Wholesale market DR signals and price and product communication have different characteristics
224 than retail market DR signals and price and product communication, although Energy
225 Interoperation defines a commonality in format.
- 226 3. It is likely that most end users, with some exceptions among Commercial and Industrial (C&I)
227 customers, will not interact directly with wholesale market.
- 228 4. Retail pricing models are complex, due to the numerous tariff rate structures that exist in both
229 regulated and un-regulated markets. Attempts to standardize DR control and pricing signals must
230 not hinder regulatory changes or market innovations when it comes to future tariff or pricing
231 models.
- 232 5. New business entities such as Energy Service Providers (ESP), Demand Response Providers
233 (DRP), DR Aggregators, and Energy Information Service Providers (ESIP), will play an increasing
234 role in DR implementation. Energy Interoperation supports these and new as yet unnamed
235 intermediation services.
- 236 6. DER may play an increasingly important role in DR, yet the development of tariff and/or pricing
237 models that support DER's role in DR are still in early stages of development.
- 238 7. The Customer's perspective and ability to react to DR control and pricing signals must be a key
239 driver during the development of standards to support DR programs.

240 In addition, it is the policy of the Energy Interoperation Technical Committee that

241 8. Where feasible, customer interfaces and the presentation of energy information to the customer
242 should be left in the hands of the market, systems, and product developers enabled by these
243 specifications.

244 The NAESB Smart Grid Committee [REFERENCE] provided guidance on the DR and the electricity
245 market customer interactions, as a required input under NIST Smart Grid Priority Action Plan 9
246 (PAP09). Energy Interoperation relied on this guidance. The service definitions, especially, relied on
247 the documents developed to support the NAESB effort in the wholesale [IRC] and retail [OpenSG]
248 markets.

249 2.2.1 Specific scope statements

250 Interaction patterns and service definitions to support the following are in scope for Energy Interoperation:

- 251 • Market communications to support transactive energy. (see [TEMIX])
- 252 • Specific offerings by end nodes to alter energy use.
- 253 • Measurement and confirmation of actions taken, including but not limited to curtailment,
254 generation, and storage, including load and usage information, historical, present, and projected.
- 255 • Notifications requesting performance on contracts offered or executed
- 256 • Information models for contracts and product communication
- 257 • Service definitions for Energy Interoperation

258 The following are out of scope for Energy Interoperation:

- 259 • Requirements specifying the type of contract, agreement, or tariff used by a particular market.
- 260 • Validation and verification of contract performance, except for validation of curtailment and
261 generation.
- 262 • Communication (e.g. transport method) other than Web services to carry the messages from one
263 point to another. The messages specified in Energy Interoperation can be transmitted via a
264 variety of transports.

265 2.3 Background & Approach [Not Normative]

266 Today's markets are not necessarily tomorrow's. Today's retail markets have grown up around conflicting
267 market restrictions, tariffs that are contrary to the goals of smart energy, and historical practices that pre-
268 date automated metering and e-commerce. Today's wholesale market applications, designed, built and
269 deployed in the absence of standards resulting in little or no interchangeability among vendor products,
270 complex integration techniques, and duplicated product development. The Technical Committee opted to
271 avoid direct engagement with these problems. While Energy Interoperation aims for future flexibility while
272 it addresses the problems of today.

273 While the focus today is on on-demand load reduction, on-demand load increase is just as critical for
274 smart energy interactions. Any large component of intermittent energy sources will create temporary
275 surpluses as well as surfeits. Interactions between different smart grids and between smart grids and end
276 nodes must maximize load shifting to reflect changing surpluses or shortages of electricity.
277 Responsibilities and benefits must accrue together to the participants most willing and able to adapt.

278 The Committee, working with the [EMIX] Technical Committee developed a component model of an
279 idealized market for electricity transactions. This model assumes timely automated interval metering and
280 an e-commerce infrastructure. TEMIX describes electricity in this normal market context. This model was
281 explained in the [TEMIX] paper, an approved work product of the EMIX committee. Using the
282 components in this model, the authors were then able to go back and simulate the market operations of
283 today.

284 Energy Interoperation supports four essential market activities:

- 285 1. There is an **indication of interest** (trying to find tenders to buy or sell) when a Party is seeking
286 partner Parties for a demand response contract or for an energy source or sale.

- 287 2. There is a **tender** (offer or bid) to buy or sell a service, e.g. production of energy or curtailment of
288 use.
289 3. There is an **execution** of a contract (transaction to purchase / supply) generally caused by the
290 acceptance of a tender.
291 4. For some contracts, such as Demand Response, there may be a **call for performance** of a
292 contract at the agreed-upon price, time, and place.

293 Version 1.0 of Energy Interoperation does not define the critical fifth market activity, **measurement and**
294 **verification** (M&V). A NAESB task force is currently (December 2010) defining the business
295 requirements for M&V.

296 Other business models may combine services in novel ways. An aggregator can publish an indication of
297 interest in to buy curtailment at a given price. A business willing to respond would offer a agreement to
298 shed load for a specific price. The aggregator may accept some or all of these offers. The performance in
299 this case could be called at the same time as the tender acceptance or later.

300 Communication of price is at the core all of the Energy Interoperation services. We identify four types of
301 prices:

- 302 1. Priced Offer: a forward offer to buy or sell a quantity of an energy product for a specified future
303 interval of time the acceptance of which by a counterparty results in a binding agreement. This
304 includes tariff priced offers where the quantity may be limited only by the service connection and
305 DR prices.
- 306 2. Ex-Post Price: A price assigned to energy purchased or sold that is calculated or assigned after
307 delivery. Price may be set based on market indices, centralized market clearing, tariff calculation
308 or any other process.
- 309 3. Priced Indication of Interest: the same as a Priced Offer except that no binding agreement is
310 immediately intended.
- 311 4. Historical Price: A current price, past contracted price, past offered price, and statistics about
312 historical price such as high and low prices, averages and volatility.
- 313 5. Price Forecast: A forecast by a party of future prices that are not a Priced Indication of Interest or
314 Priced Offer. The quality of a price forecast will depend on the source and future market
315 conditions

316 A grid pricing service is able to answer the following sorts of questions:

- 317 1. What is the price of Electricity now?
- 318 2. What will it be in 5 minutes?
- 319 3. What was the highest price for electricity in the last day? Month? Year?
- 320 4. What was the lowest price for electricity in the last day? Month? Year?
- 321 5. What was the high price for the day the last time it was this hot?
- 322 6. What price will electricity have for each hour of the day tomorrow?
- 323 7. What will it be at other times in the future?

324 Each answer carries with it varying degrees of certainty. The prices may be fixed tariffs absolutely locked
325 down. The prices may be fixed tariffs, "unless a DR event is called." The prices may be wild guesses
326 about open markets. With a standardized price service, technology providers can develop solutions to
327 help grid operators and grid customers manage their energy use portfolios.

328 Emergency or "Grid Reliability" events are also encompassed by this approach. Grid Reliability events
329 require mandatory participation in today's markets. These can be described as standing pre-executed
330 option contracts. A grid operator then need merely call for performance as in any other event.

331 2.4 Assumptions

332 2.4.1 Availability of Interval Metering

333 Energy Interoperation for many actions presumes a capability of interval metering where the interval is
334 smaller than the billing cycle. Interval metering may be required for settlement or operations for

335 measurement and verification of curtailment, distributed energy resources, and for other Energy
336 Interoperation interactions.

337 **2.4.2 Use of EMIX**

338 This specification uses the OASIS Energy Market Information Exchange [EMIX] to communicate product
339 definitions, quantities, and prices. EMIX provides a succinct way to indicate how prices, quantities, or both
340 vary over time.

341 **2.4.3 Use of WS-Calendar**

342 This specification uses the OASIS [WS-Calendar] specification to communicate schedules and intervals.
343 WS-Calendar is the standard under the NIST Smart Grid Roadmap for all such communication.

344 WS-Calendar expresses a general approach to communications of sequences and schedules, and their
345 gradual complete instantiation during contracts. Despite its name, WS-Calendar does not require that
346 communications use web services.

347 **2.4.4 Energy Services Interface**

348 The Energy Services Interface (ESI) is the external face of the energy management systems in the end
349 node. The ESI facilitates the communications among the entities (e.g. utilities, ISOs) that produce and
350 distribute electricity and the entities (e.g. facilities and aggregators) that manage the consumption of
351 electricity. An ESI may be in front of one system or several, one building or several, or even in front of a
352 microgrid.

353 This work assumes that there is no direct interaction across the ESI.

354 **3 Energy Interoperation Architecture**

355 This section provides an overview of the interaction structure, and defines the roles and actors in
356 electricity markets. Later sections will define the interactions more carefully as services.

357 **3.1 Structure of Actors, Roles and Interactions**

358 The Energy Interoperation (EI) architecture views interoperation as taking place in the context of an
359 interaction between two or more actors. Actors may perform in a chain of actors and supporting actors.

360 The actor for all EI interactions is a Party. An actor is a Party that can take on a number of roles. This
361 terminology follows common business interaction terminology wherein suppliers sell to intermediaries who
362 may buy transport services and sell to end use customers.

363 A Party can be an end use customer, a generator, a retail service provider, a demand response provider,
364 a marketer, a distribution system operator, a transmission system operator, a system operator such as an
365 ISO or RTO, a microgrid operator, or any party engaging in transactions or supporting transactions for
366 energy.

367 Parties may participate in many interactions concurrently as well as over time. In theory, any Party can
368 transact with any other Party subject to applicable regulatory restrictions. In practice, markets will
369 establish interactions between Parties based on regulation, convenience, economics, credit, network
370 structure, locations, and other factors.

371 **3.1.1 Transactive Roles and Interactions**

372 A Party can take on two basic roles:

- 373 • Buyer and
- 374 • Seller

375 At any moment, each Party has a position in the market. A Party selling power relative to its current
376 position takes the role of a seller. A Party buying power relative to its current position takes the role of a
377 buyer. A generator typically takes the role of a Seller, but can also take on the role of a Buyer. A
378 generator may take the role a Buyer in order to reduce generation because of a change in generator or
379 market conditions. An end-use customer typically takes the role of a Buyer, but if tendered an attractive
380 price may curtail usage and thereby take the role of a Seller.

381 A distributed generator certainly can take on the roles of buyer and seller. If a distributed generator sells 2
382 MW forward of a given interval, it may later decide to buy back all or a portion of the 2 MW if the price is
383 low enough. A distributed storage device takes on the roles of buyer and seller at different times.

384 Parties taking on the roles of Buyers and Sellers interact both through tenders for transactions and
385 through transactions as illustrated in Figure 2.

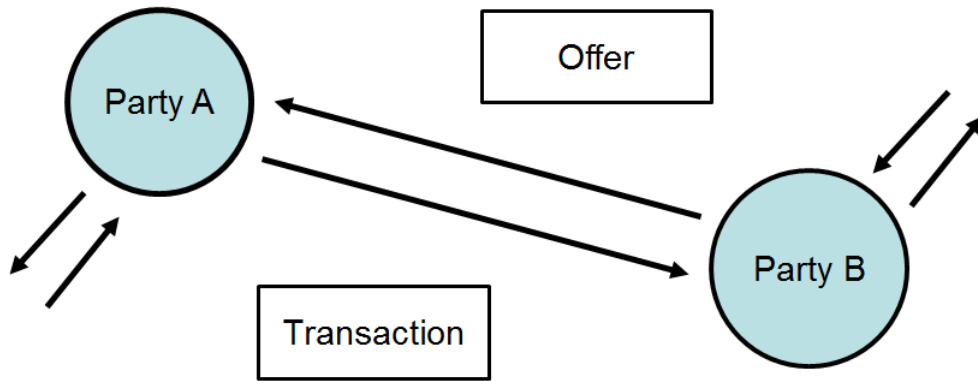

386
387

Figure 3-1: Parties Interacting with Offers and Transactions as Either Buyers or Sellers.

388 If the Tender is a buy offer by B, then when the Tender is accepted by A, A then becomes the Seller and
 389 B the Buyer with respect to the new Transaction. The term transaction and contract are used
 390 interchangeably in this document. Typically, an Agreement (or Program) will be an enabling agreement
 391 among many parties that facilitates many contracts under the terms of the enabling Agreement.

392 **3.1.2 Option Transaction Roles and Interactions**

393 Two parties can also engage in option transactions. An option is a promise granted by the first Party
 394 (Promisor) to the second Party (Promisee) usually for some consideration. The Promisee is granted a
 395 right to invoke specific transactions (operations) that the Promisor promises to perform. Demand
 396 response, ancillary services, and energy option transactions are forms of options.

397 Any Party may take the role of a Buyer or Seller of a tender for an option transaction. After an offer of an
 398 option is executed, one Party takes the role of Promisor and the other takes the role of Promisee. These
 399 roles of Parties and interactions among them are illustrated in Figure 3:

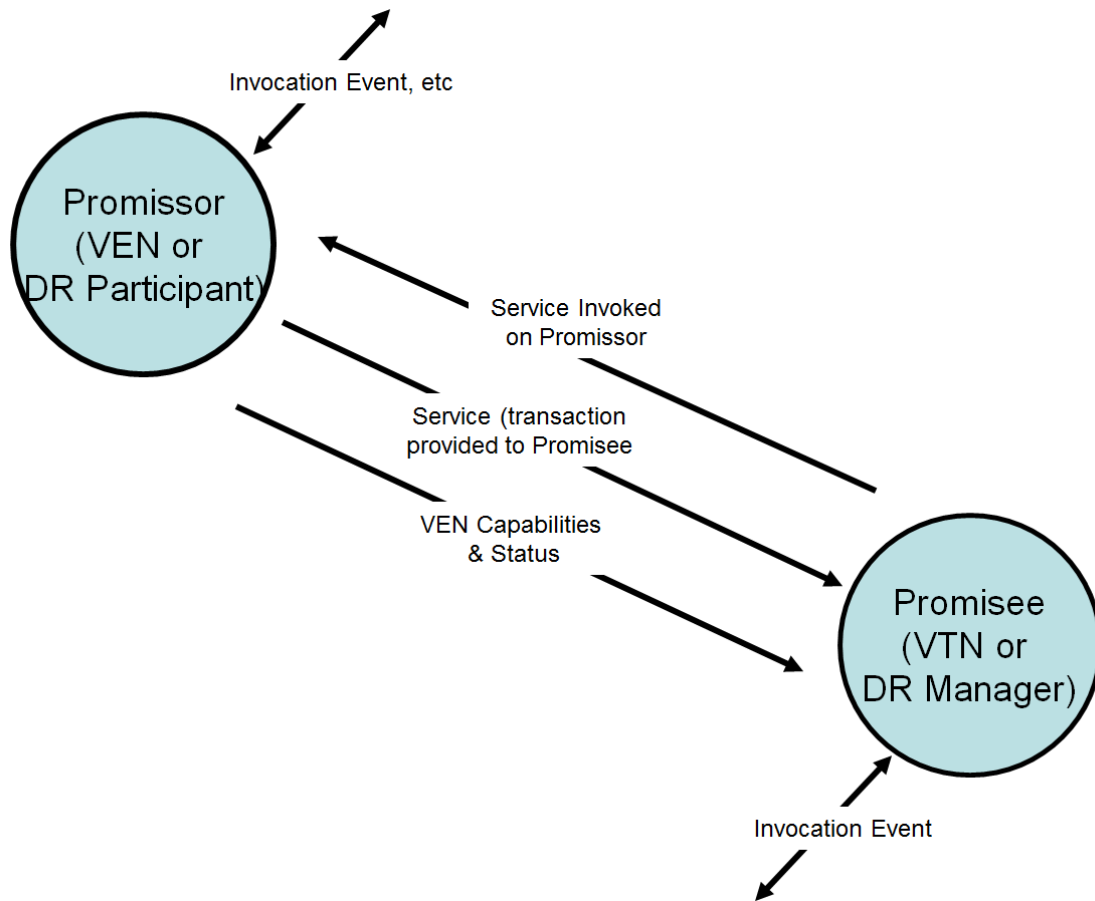

Figure 3-2: Option Roles and Interactions

400
401

402 In the case of a demand response (DR) option, the DR Manager is in the Promisee Role and the DR
403 Participant is in the Promissor Role.

404 Figure 3-2 illustrates a more general terminology for both Demand Response and for third party resource
405 dispatch: the role of Promissor is called the Virtual Top Node (VTN) and the role of Promisee is called the
406 Virtual End Node (VEN).

407 Informally and interchangeably we will write that a Party implements the role of Buyer or Seller. But a
408 Buyer and Seller of options such as demand response options may also implement the roles of VTN and
409 VEN for that interaction.

410 Interoperation between a VTN and VEN has several steps as shown in Figure 3-2. Typically a VEN
411 communicates its capabilities and status to a VTN. At some point, an invocation event caused a VTN to
412 invoke a service on the VEN. The VEN then responds by scheduling a transaction that when executed
413 results in a delivery of energy services.

414 3.2 Demand Response and Resource Dispatch Interactions

415 The Energy Interoperation architecture views interoperation taking place in the context of an interaction
416 between two or more actors, where one designated actor is (for that given interaction) called **Virtual Top
417 Node (VTN)** and the remaining one or more actors are called **Virtual End Node(s) [VEN(s)]**.¹

¹ We are indebted for the Virtual End Node term to EPRI,
http://my.epri.com/portal/server.pt?Abstract_id=00000000001020432

418 Parties may participate in many interactions concurrently as well as over time. For example, a particular
419 Actor may participate in multiple Demand Response programs, receive price communication from multiple
420 sources, and may in turn distribute signals to additional sets of Parties.

421 Energy Interoperation combines and composes multiple sets of pairwise interactions to implement more
422 complex structures. By using simple pairwise interactions, the computational and business complexity for
423 each set of Parties is limited, but the complexity of the overall interaction is not limited.

424 3.2.1 Sample Interaction Patterns

425 In this section, we clarify terminology for roles in Energy Interoperation interaction patterns. The
426 description and approach is consistent with the Service-Oriented Architecture Reference Model **[SOA-
427 RM]**. All interactions SHALL be between two or more Parties. The role of a Party as a VTN or VEN only
428 has meaning within the context of a particular service interaction.

429 At this level of description, we ignore the presence of application level acknowledgement of invocations,
430 as that acknowledgement are typically implemented by composing with **[WS-RM]**, **[WS-Reliability]**, **[WS-
431 SecureConversation]** or a similar mechanism. For similar reasons, an actual deployment would
432 compose in the necessary security, e.g., **[WS-Security]**, **[SAML]**, **[XACML]**, or **[WS-
433 SecureConversation]**.

434 We also ignore typical push or pull patterns for interactions, which are deferred to later sections.

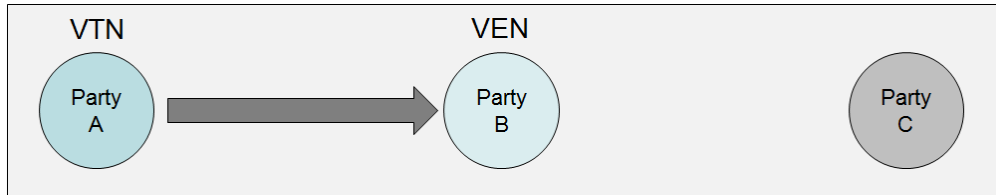

435
436 *Figure 3-3: Example DR Interaction One*

437 In Figure 3-3:, Party A is the VTN with respect to Party B, which is acting as the VEN. Party C is not a
438 party to this interaction.

439 Subsequently, as shown in Figure 4, Party B may act as the VTN for an interaction with Party C, which is
440 acting as the VEN for interaction two. Party A is not for a party to interaction two in Figure 3-3:.

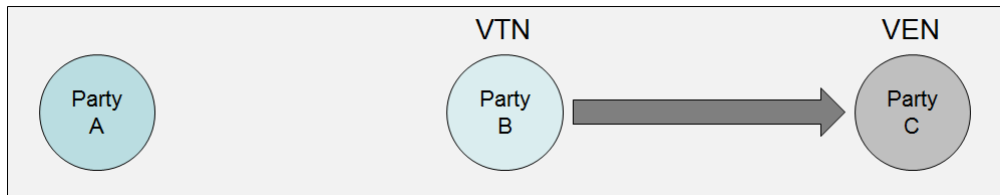

441
442 *Figure 3-4 Example DR Interaction Two*

443 Moreover, the directionality and the roles of the interaction can change as shown in Figure 3-4 Again,
444 Party A is not a party to this interaction, but now Party C is the VTN and Party B is the VEN.

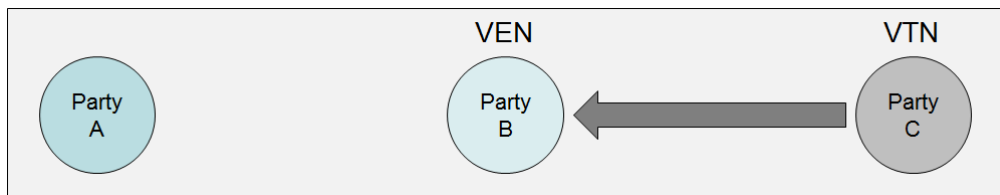

445
446 *Figure 3-5: Example DR Interaction Three*

447 There is no hierarchy implied by these examples—we are using them to show how the pairwise
448 interaction patterns and the respective roles that entities play can be composed in ways that are limited
449 only by business needs and feasibility, and not by the architecture. From these simple interactions, one
450 can construct more complex interactions as shown in Figure 3-6:

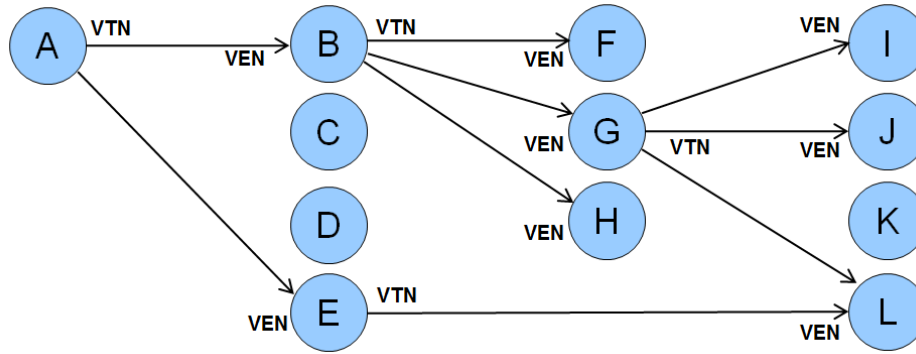

Figure 3-6: Web of Example DR Interactions

451
 452
 453 In this figure, certain Parties (B, E, and G) act as both VTN and VEN. This directed graph with arrows
 454 from VTN to its VENs could model a Reliability DR Event initiated by the Independent System Operator²
 455 A who would invoke an operation on its second level VTNs B-E, which could be a group of aggregators.
 456 The second level VTN B, in turn invokes the same service on its VENs FGH, who may represent their
 457 customers or contracted resources. Those customers might be industrial parks with multiple facilities, real
 458 estate developments with multiple tenants, or a company headquarters with facilities in many different
 459 geographical areas, who would invoke the same operation on their VENs.

460 Each interaction can have its own security and reliability composed as needed—the requirements vary for
 461 specific interactions.

462 The following table has sample functional names for selected nodes.

Table 3—1: Interactions and Actors

Label	Structure Role	Possible Actor Names
A	VTN	System Operator, DR Event Initiator, Microgrid controller, landlord
B	VEN (wrt A), VTN (wrt F, G, H)	Aggregator, microgrid element, tenant, floor, building, factory
G	VEN (wrt B), VTN (wrt I, J, L)	Microgrid controller, building, floor, office suite, process controller, machine
L	VEN (wrt G and wrt E)	Microgrid element, floor, HVAC unit, machine

465
 466 **3.2.2 Roles and Services**
 467 We have defined two structured roles in each interaction, the Virtual Top Node (VTN) and the Virtual End
 468 Node (VEN). A **VTN** has one or more associated **VENs**.³

469 Considering service interactions for Energy Interoperation, each **VTN** may invoke services implemented
 470 by one or more of its associated **VENs**, and each **VEN** may invoke services implemented by its
 471 associated **VTN**.

472 In later sections we detail abstract services that address common transactions, Demand Response, price
 473 distribution, and other use cases.

² Using North American Terminology.

³ The case of a VTN with zero VENs may be theoretically interesting but has little practical value, hence in a later section we formally describe the VENs having cardinality 1..n.

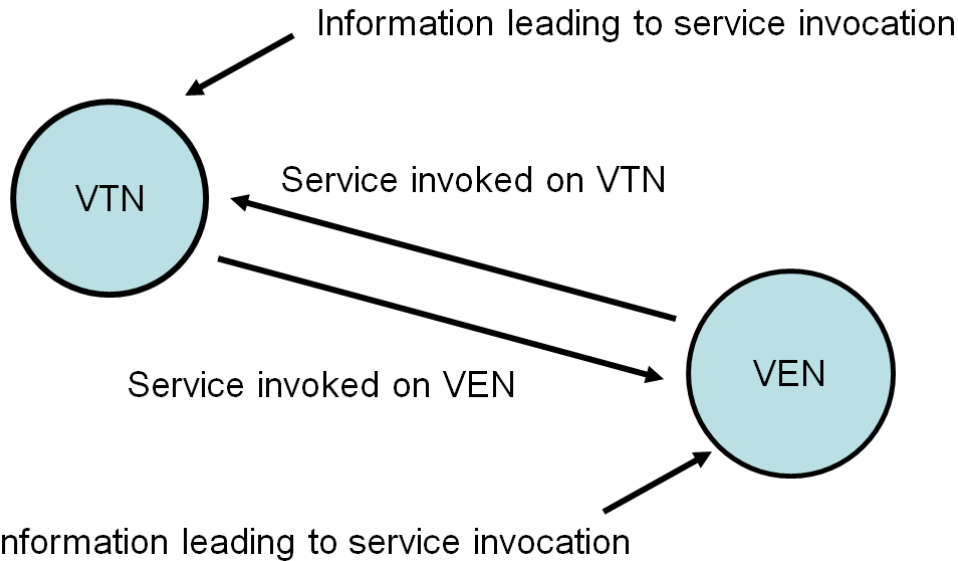

Figure 3-7: Service Interactions between a **VTN** and a **VEN**

474 Information leading to service invocation
 475
 476 The interacting pairs can be connected into a more complex structure as we showed in Figure 3-6.
 477 The relationship of one or more **VENs** to a **VTN** mirrors common configurations where a VTN (say an
 478 aggregator) has many VENs (say its contracted resources) and each VEN works with one VTN for a
 479 particular interaction.⁴
 480 Second, as we have seen, each **VEN** can implement the **VTN** interface for another interaction.
 481 Third, the pattern is recursive as we showed above in Figure 3-6: and allows for more complex
 482 structures.⁵
 483 Finally, the Parties of the directed interaction graph can be of varying types or classes. In a Reliability DR
 484 Event, a System Operator as a VTN may initiate the event with the service invoked on its next level
 485 (highest) VENs, and so forth. But the same picture can be used to describe many other kinds of
 486 interaction, e.g. interactions to, from, or within a microgrid [**Galvin**], price and product definition
 487 distribution, or distribution and aggregation of projected load and usage.
 488 In some cases the structure graph may permit cycles, in others not.

3.2.3 Services and Demand Response Interaction Patterns

490 In this section we describe the interaction patterns of the services for demand response respectively
 491 invoked by an **VTN** on one or all of its associated **VENs** and vice versa. **Error! Reference source not**
 492 **found.** above shows the generic interaction pattern; Figure 3-7: below is specific to Demand Response
 493 Events.
 494 By applying the recursive definitions of VTN and VEN, we will define specific services in the next sections.
 495 See Figure 3-8: for service names which are defined more fully in the following sections.
 496 The VTN invokes operations on its VENs such as Initiate DR Event and Cancel DR Event, while the VEN
 497 invokes operations on its VTN such as Submit DR Standing Bid and Set DR Event Feedback.
 498 Note not all DR works this way. A customer may be sent a curtailment tender by the DR provider with a
 499 price and then can decide to respond. If the customer has agreed to a capacity payment then there may

⁴ The model allows e.g. Demand Resources to participate in more than one interaction, that is, in more than one Demand Response program or offer or with more than one aggregator.

⁵ For example, [**OpenADR1.0**] has four actors (the Utility, Demand Response Application Server, the Participant, and the Client (of the Participant)). The Energy Interoperation architecture maps clearly to the DRAS-Participant interface, and models the Participant-Client interface as an additional VTN-VEN relationship.

500 be a loss of payments if he does not respond, As shown below, standing bids do not require an event
501 notification, only a notification of acceptance.

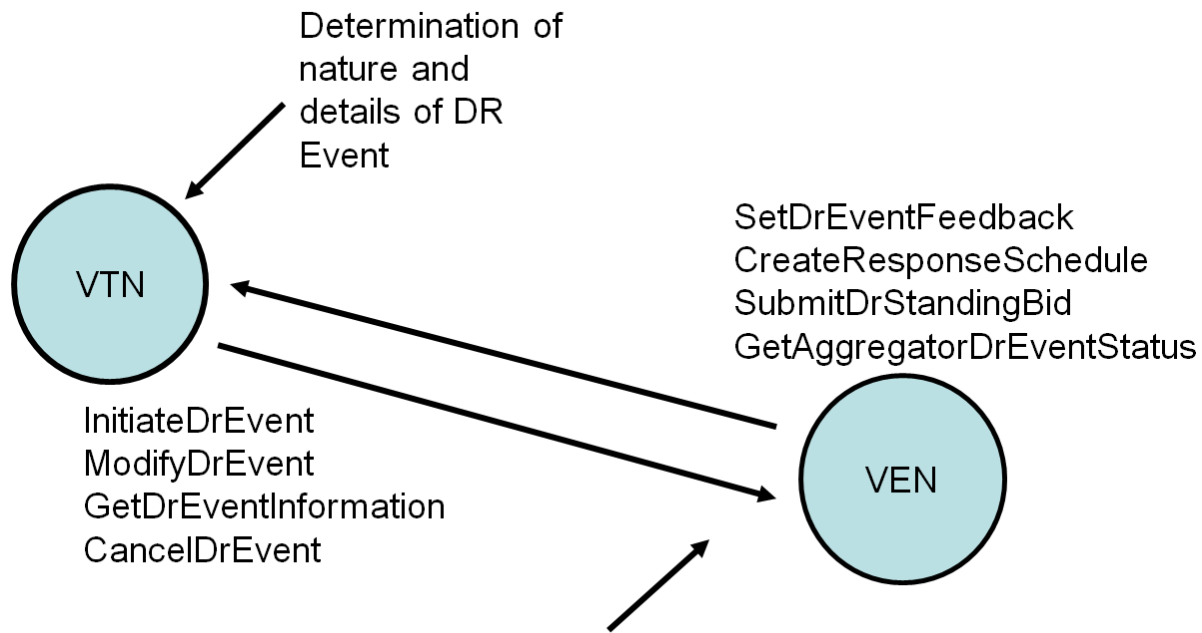

502
503

Figure 3-8: Demand Response Interaction Pattern Example

504 4 Message Composition & Services

505 At initial glance, Power and Load Management are simple. Turn on generation. Turn off the lights. The
506 price has just doubled. I won't turn on any resource for less than \$100. Energy interoperation addresses
507 these issues through the repeated use of two other standards, Energy Market Information Exchange
508 (EMIX) and WS-Calendar.

509 EMIX describes price and product for electricity markets. WS-Calendar communicates schedules and
510 sequences of operations. Together these describe the complexity of the services and events that are
511 provided by Energy Interoperation.

512 4.1 WS-Calendar in Energy Interop

513 WS-Calendar describes how service delivery changes over time. WS-Calendar is based upon the
514 enterprise calendar communications standard iCalendar. WS-Calendar simplifies the essential
515 appointment of iCalendar into the interval. Each interval is able to hold an artifact from another space, say
516 a DR event or power quantity and price. Intervals are then built up, one after the other, into sequences.

517 WS-Calendar includes elements to express schedules and gaps and parallel interactions using
518 sequences. While this complexity is available to the practitioner, it is not required in implementation.

519 WS-Calendar is used by EMIX to define Products, i.e., services in contracts, from EMIX Product
520 Descriptions, which are described below. WS-Calendar is also used directly in a number of Energy
521 Interoperation interfaces, whenever a service communicates a schedule for service delivery.

522 WS-Calendar is also used to describe other schedule-related aspects of Energy markets. For example,
523 reserve generation may be on call only on summer afternoons on weekdays. Some tariffs may specify
524 that Demand Response events are available only on a similar schedule. This can be hard to describe *de*
525 *novo*. It is a common use of iCalendar to schedule a meeting for Mondays and Wednesdays for the next
526 two months. Because WS-Calendar is derived from iCalendar, it is able to express this availability, which
527 in Energy Interop we call Business Schedules, easily and completely.

528 WS-Calendar gluons associate with intervals in a sequence and share information with them. Gluons can
529 control the start time and duration of intervals in a sequence. Gluons can contain the same artifacts as do
530 intervals. A complex artifact may be shared between Gluon and each Interval in a sequence, so that
531 invariant information is expressed only once, in the Gluon, and the information that changes over time,
532 perhaps price or quantity, is the only part of the Artifact in each interval.

533 To fully understand the expressiveness of [WS-Calendar], one should read that specification.

534 4.1.1 Simple Sequences in WS-Calendar

535 Nearly every response, every event, and every interaction in Energy Interoperation can have a payload
536 that varies over time, i.e., it is described using a sequence of intervals. Even so, most communications,
537 particularly in today's retail market, involve information about or a request for a single interval. Simplicity
538 and parsimony of expression must coexist with complexity and syntactical richness.

539 The simplest power description, in EMIX is transactional power. The simplest demand response is to
540 reduce power. The power object in EMIX can include specification of voltage, and Hertz and quality and
541 other features. There are market interactions where each all of those are necessary. Reduced to its
542 simplest, though, the EMIX Power information consists of Power Units and Power Quantity: as in

Units:	KW	Quantity	10
--------	----	----------	----

543
544 *Figure 4—1: Basic Power Object from EMIX*

545 At its simplest, though, WS-Calendar expresses repeating intervals of the same duration, one after the
546 other, and something that changes over the course of the schedule

Start:	8:00	Duration:	1Hour		
		Duration:	1Hour		
		Duration:	1Hour		
		Duration:	1Hour		
		Duration:	1Hour		

547
548

Figure 4—2: WS-Calendar Partition, a simple sequence of 5 intervals

549 The WS-Calendar specification defines how to spread an object like the first over the schedule. The
550 information that is true for every interval is expressed once only. The information that changes during
551 each interval, is expressed as part of each interval.

Units	KW	Start:	8:00	Duration:	1Hour	Quantity	10
				Duration:	1Hour	Quantity	10
				Duration:	1Hour	Quantity	15
				Duration:	1Hour	Quantity	25
				Duration:	1Hour	Quantity	10

552
553

Figure 4—3: Applying Basic Power to a Sequence

554 Most communications, particularly those in Demand Response, communicate requirements for a single
555 interval. When expressing market information about a single interval, the market object (Power) and the
556 single interval collapse to a simple model:

Units	KW	Start:	8:00	Duration:	1Hour	Quantity	10
-------	----	--------	------	-----------	-------	----------	----

557
558

Figure 4—4: Simplifying back to Power in a Single Interval

559 In Energy Interoperation, all intervals are expressed using the structure of WS-Calendar. In most
560 interactions, these messages look like Figure 4—4, simple and compact. When an information element is
561 more complex, and varies over time, it may expand as in Figure 4—3. But in all cases, DR Events, Price
562 Quotes, or Program Calls, the essential message is an Information object applied to a WS-Calendar
563 sequence.

564 4.2 EMIX and Energy Interop

565 EMIX provides price and product definitions for electricity markets. EMIX elements are closely aligned
566 with the Market Interfaces as defined in the [CIM]. EMIX specifies Power Options and Power Products by
567 applying Product Descriptions to WS-Calendar Sequences. Product Descriptions are shared as Artifacts
568 across Sequences, wherein the invariant information expressed only in the Gluon, and the information
569 that changes over time, perhaps price, or quantity, in each interval.

570 EMIX describes Reserves using the language of market Options, whether they are spinning reserves, on
571 call to provide power, or are demand responsive load, ready to reduce use upon request. EMIX Options
572 describe the contract to stand ready, expressed as a business schedule. EMIX Options defines the
573 potential size of the response that can be called. The EMIX Option includes a warranted response time.
574 Finally, calling the EMIX Option, whether Power or Load, defines a strike price, which is expressed either
575 as an absolute amount or as a price relative to the current market.

576 The EMIX Resource describes a service that could be brought to market. Each Resource may have a lag
577 time before responding. Non-trivial responses may take a while during which the amount of power is
578 ramping up or down. In the IEC TC57 [CIM], these ramp rates are expressed as a Ramp Rate Curve, as
579 shown in Figure 4-5.

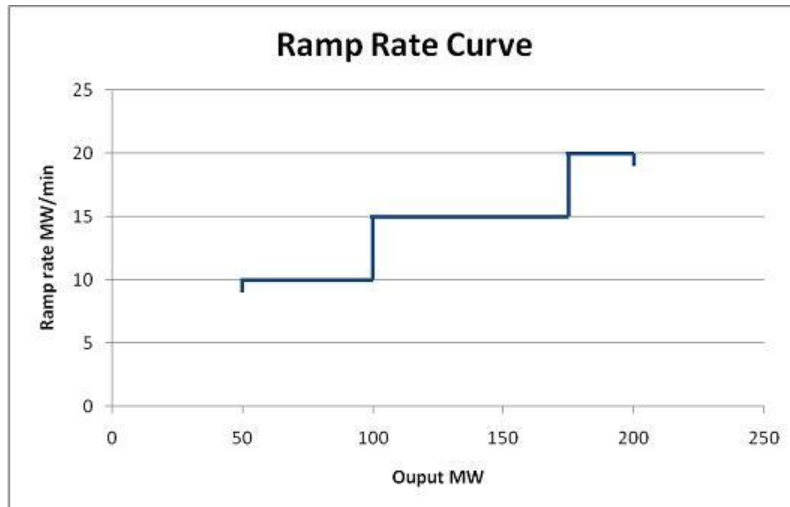

Figure 4-5: Ramp Rate Curve—CIM Style

580
581

582 Resources may also have minimum responses, or maximum run times, or minimum required times
583 between each invocation.

584 By expressing resources in terms of capabilities and ramp rates, a potential purchaser can determine if a
585 resource meets his or her needs, tendering a single resource to a variety of purchase scenarios.

586 Many message payloads in Energy Interoperation consist of the delivery of EMIX objects. The reader who
587 is not familiar with EMIX and its capabilities may have a hard time understanding what message each of
588 the services delivers.

589 The simplest EMIX object, the product describing gluon and the sequence of a single interval containing a
590 single price collapse down to product, time, duration, and price.

591 **4.3 Using Gluons to Define Contracts**

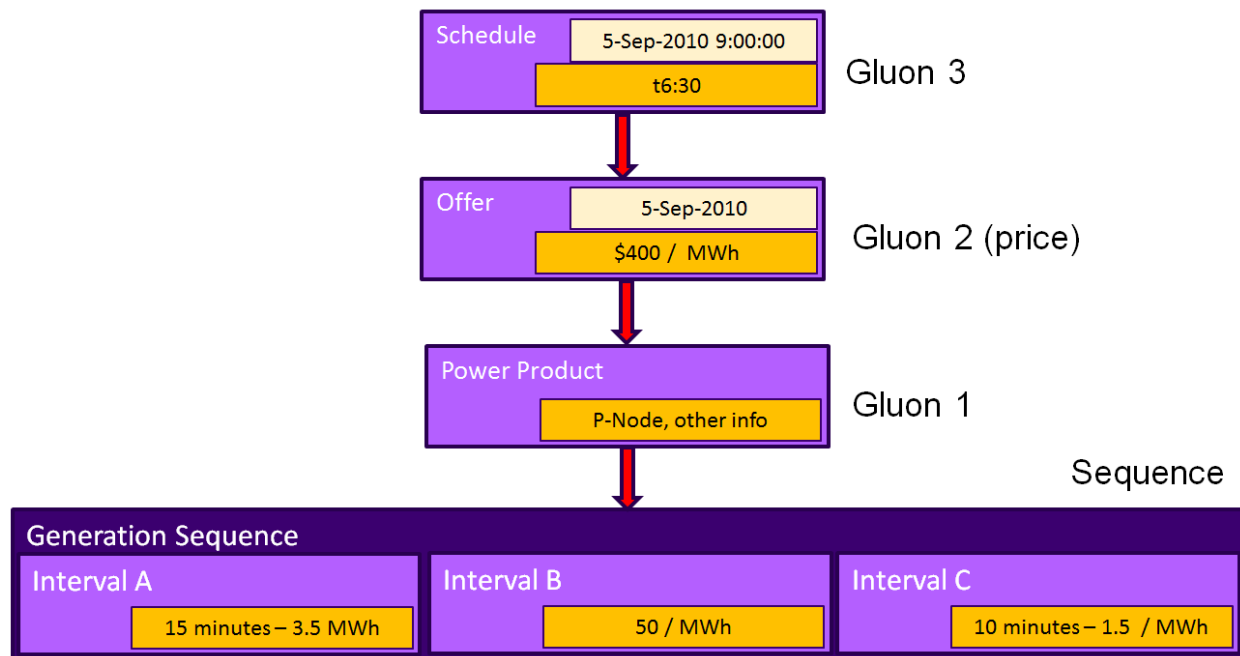

Figure 4-6: Schematic of Use of EMIX and WS-Calendar to describe Power Contract

592
593
594

1. Power source defines product to market (Sequence and Gluon 1).

- 595 2. Product is offered to market on a particular day ([1] and Gluon 2) (Date but not time, required
 596 price specified)
 597 3. Transaction specifies start time (9:00) and duration (6:30) (Gluon 3), inherited by Sequence
 598 through Gluons 2 and 1. Interval B (linked to Gluon 1) is the interval that starts at 9:00.

599 4.4 Applying EMIX and WS-Calendar to a Power Event

600 Consider the event in Figure 4-7: A Demand Response Market Schematic. This event illustrates the
 601 potential complexity of marshaling a load response from a VEN, perhaps a commercial building.

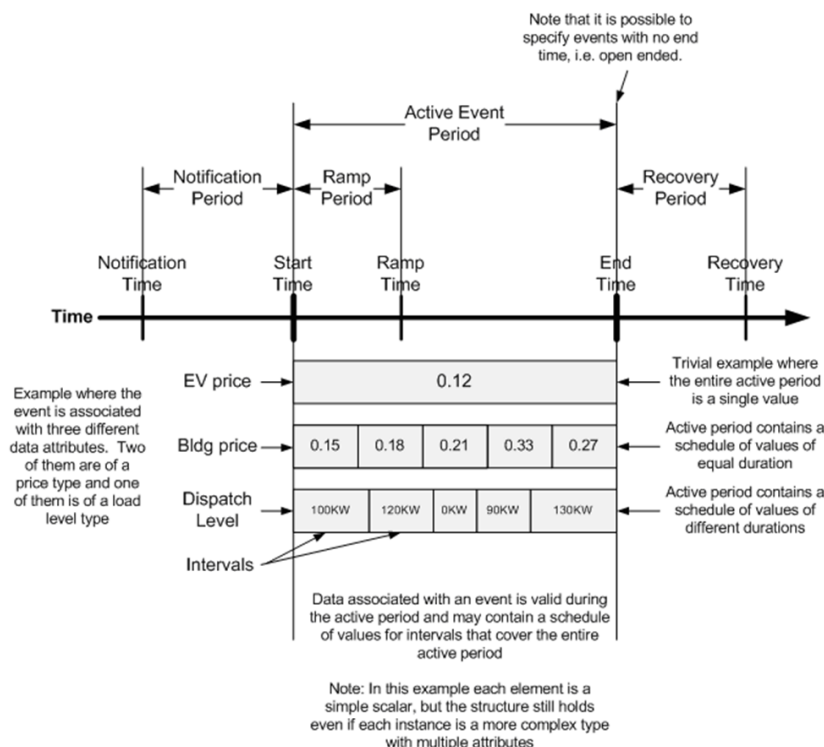

602
 603 Figure 4-7: A Demand Response Market Schematic

604 Note first that there are two schedules of prices. The Building Price of energy is rising to more than
 605 double its original price of \$0.15 during the interval. The price for Electric Vehicles (EV) is fixed at the
 606 lower-than-market rate of \$0.12, perhaps because public policy is set to encourage their use. Each of
 607 those price curves has its own EMIX description.

608 The dispatch level, i.e., the contracted load reduction made by the building, varies over time. This may be
 609 tied to building capabilities, or to maintaining essential services for the occupants. It is not important to the
 610 VTN why it is constrained, only that it is. Note that these contracted reductions do not line up with the
 611 price intervals on the bar above. In this example, the dispatch level is applied to its own WS-Calendar
 612 sequence .

613 Before and after the event, there is a notification period and a recovery period. These are fixed durations
 614 are communicated from the VEN to the VTN, which then must respect them in contracts it awards the
 615 VEN. These durations are expressed in the EMIX Resource Description provided by the VEN, and
 616 reflected in the Power Contract awarded by the VTN.

617 4.5 Introduction to Services

618 In the following sections we describe services and operations consistent with [SOA-RM]. For each
 619 service operation there is an actor that invokes the service operation and one that provides the service.
 620 We have indicated these roles by the table headings Service Consumer for the actor or role that

621 consumes or invokes the service operation named in the *Operation* column, and *Service Provider* for the
622 actor or role that provides or implements the service operation as named in the *Operation* column.
623 We use this terminology through all service definitions in this standard.
624 The column labeled *Response Operation* lists the name of the service operation invoked as a response.
625 Most operations have a response, excepting primarily those operations that broadcast messages. The
626 roles of *Service Consumer* and *Service Provider* are reversed for the *Response Operation*.

5 Security and Composition [Non-Normative]

627

628 In this section, we describe the enterprise software approach to security and composition as applied to
629 this Energy Interoperation specification.

630 Service orientation has driven a great simplification of interoperation, wherein software is no longer based
631 on Application Programming Interfaces (APIs) but is based on exchange of information in a defined
632 pattern of services and service operations [SOA-RM].

633 The approach for enterprise software has evolved to defining key services and information to be
634 exchanged, without definitively specifying how to communicate with services and how to exchange
635 information—there are many requirements for distributed applications in many environments that cannot
636 be taken into account in a service and information standard. To make such choices is the realm of other
637 standards for specific areas of practice, and even there due care must be taken to avoid creating a
638 monoculture of security.⁶

5.1 Security and Reliability Example

639

640 Different interactions require different choices for security, privacy, and reliability. Consider the following
641 set of specifics. (We repeat the figure and re-label it.)

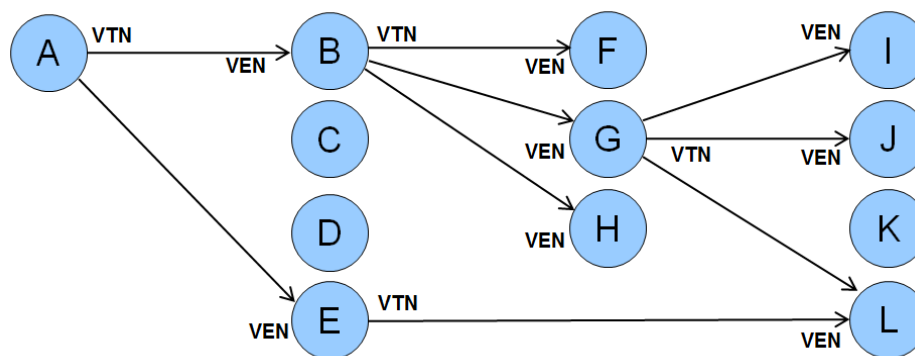

642

643

Figure 5-1: Web of Example DR Interactions

644 We specifically model a Reliability DR Event initiated by the Independent System Operator⁷ A, who sends
645 a reliability event to its first-level aggregators B through E. Aggregator B, in turn invokes the same service
646 on its customers (say real estate landlords) F, G, and H.

647 Those customers might be industrial parks with multiple facilities, real estate developments with multiple
648 tenants, or a company headquarters with facilities in many different geographical areas, which would
649 invoke the same operation on their VENs.

650 For our example, say that G is a big-box store regional headquarters and I, J, and L are their stores in the
651 affected area.

652 Each interaction will have its own security and reliability composed as needed—the requirements vary for
653 specific interactions. For example

- 654 • For service operations between A to B, typical implementations include secure private frame-
655 relay networks with guaranteed high reliability and known latency. In addition, rather than relying
656 on the highly reliable network, in this case A requires an acknowledgment message from B back
657 to A proving that the message was received.

⁶ See e.g. the STUXNET worm effects on a monoculture of software SCADA systems, 2010. See <http://en.wikipedia.org/wiki/Stuxnet>

⁷ Using North American Terminology.

- From the perspective of the ISO, the communication security and reliability between B and its customers F, G, and H may be purely the responsibility of B, who in order to carry out B's contract commitments to A will arrange its business and interactions to meet B's business needs.
- G receives the signal from aggregator B. In the contract between G and B, there are service, response, and likely security and other requirements. To meet its contractual requirements, the service operations between B and G will be implemented to satisfy the business needs of both B and G. For our example, they will use the public Internet with VPN technology and explicit acknowledgement, with a backup of pagers and phone calls in the unlikely event that the primary communication fails. And each message gets an explicit application level acknowledgement.
- Security between B and G depends on the respective security models and infrastructure supported by B and G—no one size will fit all. So that security will be used for that interaction
- The big box store chain has its own corporate security architecture and implementation, as well as reliability that meets its business needs—again, no one size will fit all, and there is tremendous variation; there is no monoculture of corporate security infrastructures.
- Store L has security, reliability, and other system design and deployment needs and implementations within the store. These may or may not be the same as the WAN connection from regional headquarters G, in fact are typically not the same (although some security aspects such as federated identity management and key distribution might be the same).
- Store L also has a relationship with aggregator E, which we will say for this example is Store L's local utility; the Public Utility Commission for the state in which L is located has mandated (in this example) that all commercial customers will use Energy Interoperation to receive certain mandated signals and price communications from the local utility. The PUC, the utility, and the owner of the store L have determined the security and reliability constraints. Once again, one size cannot fit all—and if there were one “normal” way to accommodate security and reliability, there will be a different “normal” way in different jurisdictions.

So for a simple Demand Response event distribution, we have potentially four different security profiles
 The following table has sample functional names for selected nodes.

Table 5—1: Interactions and Actors for Security and Reliability Example

Label	Structure Role	Possible Actor Names
A	VTN	System Operator
B	VEN (wrt A), VTN (wrt F, G, H)	Aggregator
G	VEN (wrt B), VTN (wrt I, J, L)	Regional Office
L	VEN (wrt G and wrt E)	Store
E	VEN (wrt A, VTN wrt L)	Local Utility

686

687 5.2 Composition

688 In state-of-the art software architecture, we have moved away from monolithic implementations and
 689 standards to ones that are composed of smaller parts. This allows the substitution of a functionally similar
 690 technology where needed, innovation in place, and innovation across possible solutions.

691 In the rich ecosystem of service and applications in use today, we *compose* or (loosely) *assemble*
 692 applications rather than craft them as one large thing. See for example OASIS Service Component
 693 Architecture [OASIS SCA], which addresses the assembly, substitution, and independent evolution of
 694 components.

695 A typical web browser or email system uses many standards from many sources, and has evolved rapidly
 696 to accommodate new requirements by being structured to allow substitution. The set of standards
 697 (information, service, or messaging) is said to be *composed* to perform the task of delivery of email.

698 Rather than creating a single application that does everything, perhaps in its own specific way, we can
699 use components of code, of standards, and of protocols to achieve our goal. This is much more efficient
700 to produce and evolve than large integrated applications such as older customized email systems.

701 In a similar manner, we say we *compose* the required security into the applications—say an aspect of
702 OASIS **[WS-Security]** and OASIS Security Access Markup Language **[SAML]**—and further *compose* the
703 required reliability, say by using OASIS **[WS-ReliableMessaging]** or perhaps the reliable messaging
704 supported in an Enterprise Service Bus that we have deployed.

705 A service specification, with specific information to be exchanged, can take advantage of and be used in
706 many different business environments without locking some in and locking some out, a great benefit to
707 flexibility, adoption, and re-use.

708 **5.3 Energy Interoperation and Security**

709 In this section we describe some specific technologies and standards in our palette for building a secure
710 and reliable implementation of Energy Interoperation. Since Energy Interoperation defines only the core
711 information exchanges and services, and other technologies are composed in, there is no optionality
712 related to security or reliability required or present in Energy Interoperation.

713 The information model in Energy Interoperation 1.0 is just that—an information model without security
714 requirements. Each implementation must determine the security needs (outside the scope of this
715 standard) broadly defined, including privacy (see e.g. OASIS Privacy Management Reference Model
716 [ref]), identity (see e.g. OASIS Identity in the Cloud, OASIS Key Management Interoperability, OASIS
717 Enterprise Key Management Infrastructure, OASIS Provisioning Services, OASIS Web Services
718 Federation TC, OASIS Web Services Secure Exchange and more)

719 Energy Interoperation defines services together with service operations, as is now best practice in
720 enterprise software. The message payloads are defined as information models, and include such artifacts
721 as Energy Market Information Exchange **[EMIX]** price and product definition, tenders, and contracts, the
722 EiEvent artifacts defined in this specification, and all information required to be exchanged for price
723 distribution, program event distribution, demand response, and distributed energy resources.

724 This allows the composition and use of required interoperation standards without restriction, drawing from
725 a palette of available standards, best practices, and technologies. The requirements to be addressed for
726 a deployment are system issues and out of scope for this specification.

727 As in other software areas, if a particular approach is commonly used a separate standard (or
728 standardized profile) may be created. In this way, WS-SecureConversation composes WS-Reliability and
729 WS-Security.

730 So Energy Interoperation defines the exchanged information, the services and operations, and as a matter
731 of scope and broad use does not address any specific application as the security, privacy, performance,
732 and reliability needs cannot be encompassed in one specification. Many of the TCs named above have
733 produced OASIS Standards,

734 (SEE http://www.oasis-open.org/committees/tc_cat.php?cat=security)

735 6 Energy Interoperation Services

736 In the following sections, we define Energy Interoperation services and operations. All communication
737 between customer devices and energy service providers is through the ESI.

738 For transactive services, the customer will receive tenders (priced offers) of service and possibly make
739 tenders (priced offers) of service.

740 If the customer is a participant in a demand response program, each ESI is the interface to a dispatchable
741 resource (Resource), that is, to a single logical entity. A Resource may or may not expose any
742 subordinate Assets.

743 Under a demand response program, an Asset is an end device that is capable of shedding load in
744 response to Demand Response Events, Electricity Price Signals or other system events (e.g. under
745 frequency detection). Assets are under the control of a Resource, and the resource has chosen to expose
746 it to the VTN. The VTN can query the State of an Asset, and can call on an asset for a response. The
747 Resource (VEN) mediates all Asset interactions, as per its agreement with the resource manager or VTN.
748 Assets, by definition, are only capable of consuming Direct Load Control and Pricing messages, and then
749 only as mediated by the Resource.

750 If an Asset, in turn, has its own Assets, it does not reveal them through the VEN. The Asset has no direct
751 interactions with the VTN.

752 Energy Interoperation uses a web services implementation to define and describe the services and
753 interactions, but fully compliant services and operations may be implemented using other technologies.

754 We divide the services into three broad categories:

- 755 • Transactive Services—for implementing energy transactions, registration, and tenders
- 756 • Event Services—for implementing events and feedback
- 757 • Support Services—for additional capabilities

758 The structure of each section is a table with the service name, operations, service provider and
759 consumer, and notes in columns.

760 The services are grouped so that profiles can be defined for purposes such as price distribution, load and
761 usage projection, and Demand Response (with the functionality of **[OpenADR]**).

762 The normative XML schemas are in separate files, accessible through the **[namespace]** on the cover
763 page.

764 **7 Transactive Services**

765 Transactive Services define and support the lifecycle of transactions inside an overarching agreement,
 766 from initial quotations and indications of interest to final settlement. The phases are

- 767 • Registration—to enable further phases
- 768 • Pre-Contract—preparation for contract with a contract the result of an accepted offer
- 769 • Contract Services—managing executed contracts
- 770 • Post-Contract—settlement, energy used or demanded, payment, position

771 For transactive services, the roles are **Parties** and **Counterparties**; as, if, and when an option contract or
 772 a Resource (Demand Response) contract is concluded, the Parties adopt a VTN or VEN role for
 773 subsequent interactions. The terminology of this section is that of business agreements: tenders, quotes,
 774 and contract execution and (possibly delayed) performance under called contract.

775 The negotiations, quotes, tenders, and acceptances that may lead to a contract also serve to define the
 776 VTN and VEN roles. Register Services

777 The register services identify the parties for future interactions. This is not the same as (e.g.) a program
 778 registration in a demand response context—here, registration can lead to exchange of tenders and
 779 quotes, which in turn may lead to a contract which will determine the VTN and VEN roles of the
 780 respective parties.

781 Registration information will be drawn from IRC and UCA and OpenADR requirements.

782 *Table 7—1: Register Services*

Service	Operation	Response	Service Consumer	Service Provider	Notes
EiRegister	EiRegisterParty	EiRegisteredParty	Party	Party	
EiRegister	EiRequestRegistration	EiSendRegistration	Party	Party	
EiRegister	EiCancelRegistration	EiCanceledRegistration	Party	Party	

783

784 **7.1.1 Information Model for the EiRegisterParty Service**

785 The details of a Party are outside the scope of this specification. The application implementation needs to
 786 identify additional information beyond that in the class EiParty.



787

788 *Figure 7-1: EiParty UML Class Diagram*

789 **7.1.2 Operation Payloads for the EiRegisterParty Service**

790 The [UML] class diagram describes the payloads for the EiFeedback service operations.

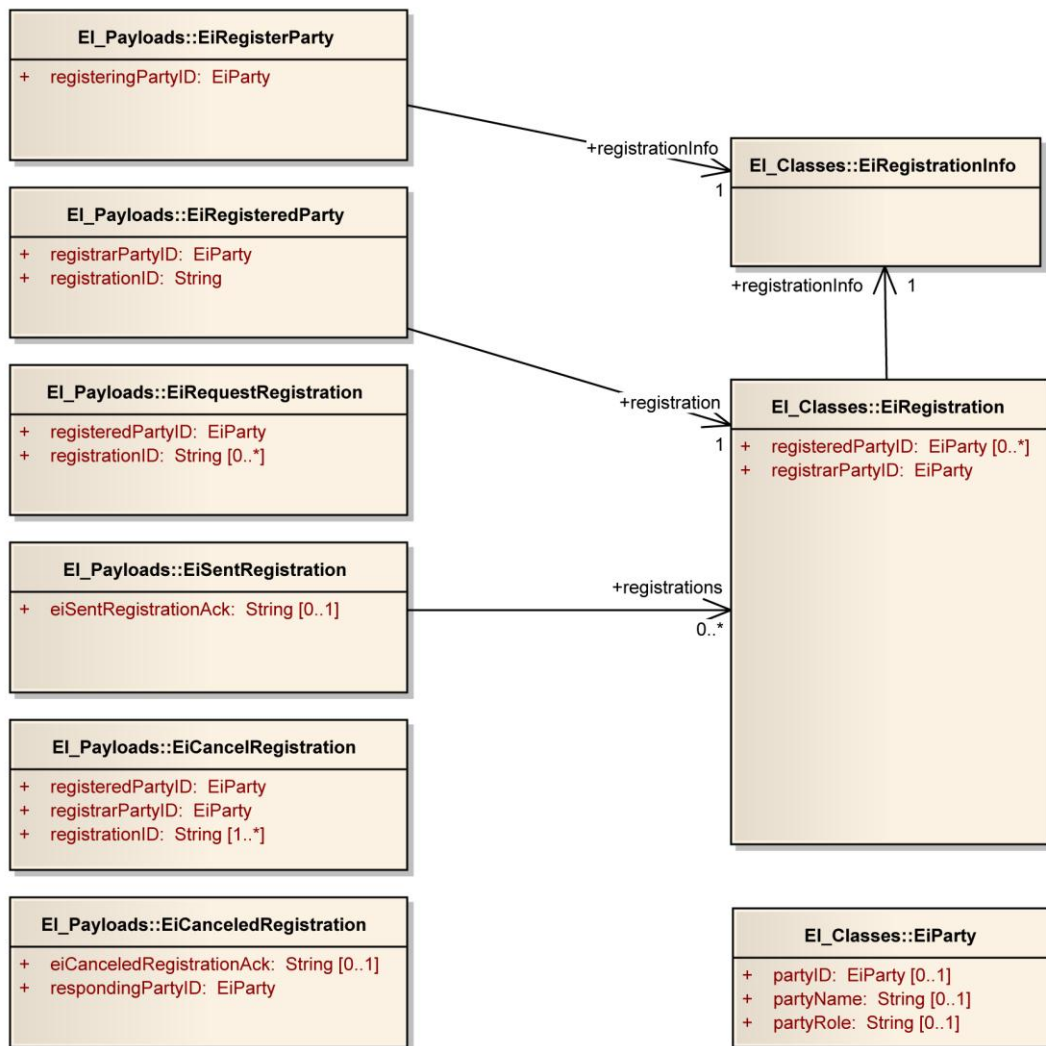

791
792 *Figure 7-2: UML Class Diagram for EiRegisterParty Service Operation Payloads*

793 **7.2 Pre-Contract Services**

794 Pre-contract services are those between parties that may or may not prepare for a contract. The services
795 are EiTender and EiQuote. A quotation is not a tender, but rather a market price or possible price, which
796 needs an tender and acceptance to reach a contract.

797 Price distribution in the sense of price signals in [OpenADR] would use the EiQuote service.

798 As with other services, a Party MAY inquire from a counterparty what offers the counterparty
799 acknowledges as open by invoking the EiSendTender service to receive the outstanding tenders.

800 There is no operation to “delete” a quote; when a quote has been canceled the counterparty MAY delete
801 it at any time. To protect against recycled or dangling references, the counterparty SHOULD invalidate
802 any identifier it maintains for the cancelled quote.

803 Tenders, quotes, and contracts are [EMIX] artifacts, which contain terms such as schedules and prices in
 804 varying degrees of specificity or concreteness.

805 *Table 7—2: Pre-Contract Tender Services*

<i>Service</i>	<i>Operation</i>	<i>Response</i>	<i>Service Consumer</i>	<i>Service Provider</i>	<i>Notes</i>
EiTender	EiCreateTender	EiCreatedTender	Party	Party	
EiTender	EiRequestTender	EiSentTender	Party	Party	
EiTender	EiAcceptTender	EiAcceptedTender	Party	Party	
EiTender	EiSendTender	EiReceivedTender	Party	Party	
EiTender	EiCancelTender	EiCanceledTender	Party	Party	

806

807 *Table 7—3: Pre-Contract Quote Services*

<i>Service</i>	<i>Operation</i>	<i>Response</i>	<i>Service Consumer</i>	<i>Service Provider</i>	<i>Notes</i>
EiQuote	EiCreateQuote	EiCreatedQuote	Party	Party	And sends the quote
EiQuote	EiCancelQuote	EiCanceledQuote	Party	Party	
EiQuote	EiRequestQuote	EiSentQuote	Party	Party	Request a quote or indication of interest (pull)
EiQuote	EiDistributeQuote	--	Party	Party	For broadcast or distribution of price (push)

808

809 **7.2.1 Information Model for the EiTender and EiQuote Service**

810 The information model for the EiTender Service and the EiQuote Service artifacts is that of [EMIX]. EMIX
 811 provides a product description as well as a schedule over time of prices and quantities.

812 **7.2.2 Operation Payloads for the EiTender Service**

813 The [UML] class diagram describes the payloads for the EiTender and EiQuote service operations.

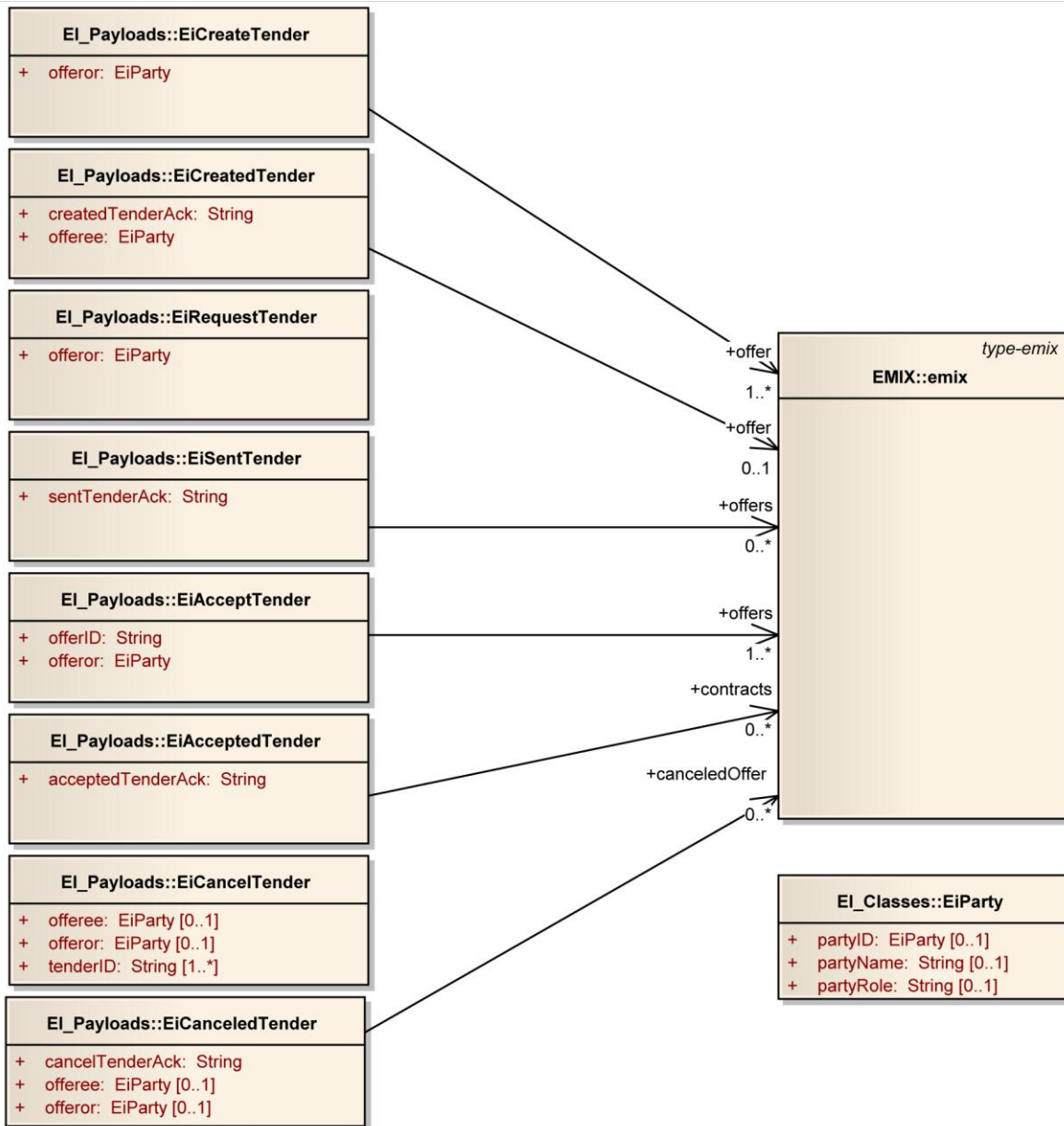

814

815

Figure 7-3: UML Class Diagram for the Operation Payloads for the EiTender Service

816

817 **7.2.3 Operation Payloads for the EiQuote Service**

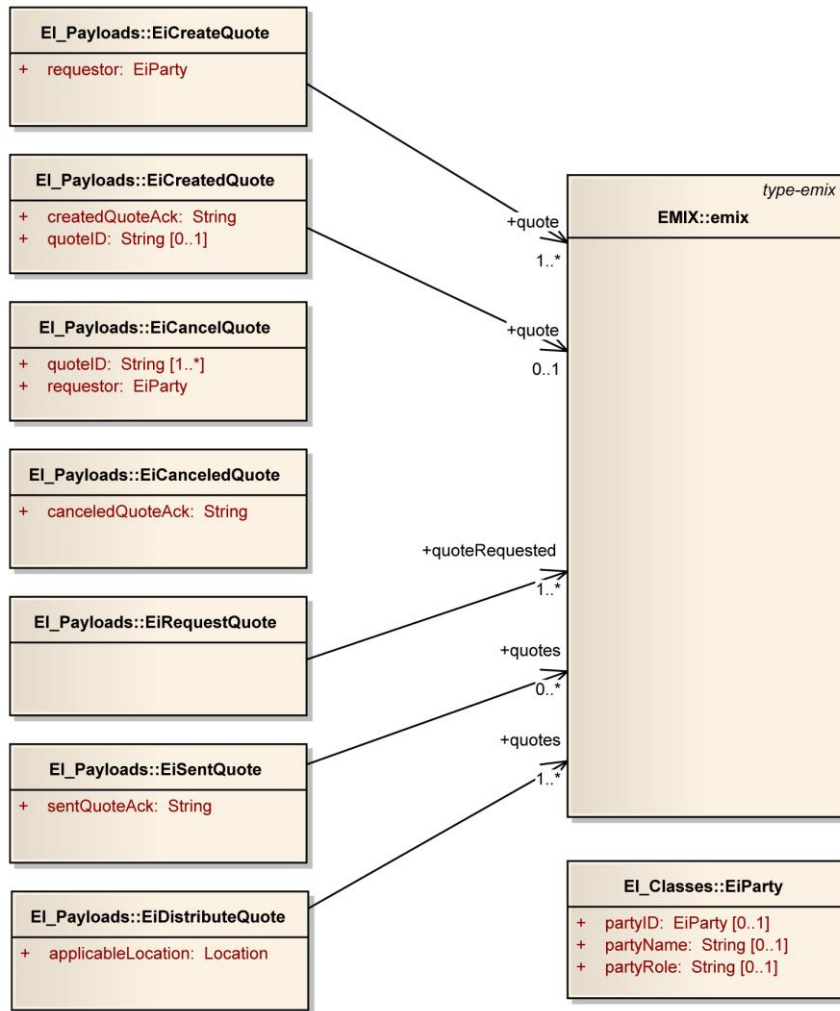

818
819 *Figure 7-4: UML Class Diagram for the EiQuote Service Operation Payloads*

820 **7.3 Contract Management Services**

821 The service operations in this section manage the exchange of contracts. For demand response, the
822 [overarching] agreement is the context in which events and response take place—what is often called a
823 *program* is identified by the information element *programName* in the EiProgram service and elsewhere.

824 *Table 7—4: Contract Management Services*

Service	Operation	Response	Service Consumer	Service Provider	Notes
EiContract	EiCreateContract	EiCreatedContract	Party	Party	And send Contract
EiContract	EiChangeContract	EiChangedContract	Party	Party	
EiContract	EiCancelContract	EiCanceledContract	Party	Party	
EiContract	EiRequestContract	EiSentContract	Party	Party	

825

826 **7.3.1 Information Model for the EiContract Service**

827 Contracts are [EMIX] artifacts with the identification of the Parties.

828 **7.3.2 Operation Payloads for the EiContract Service**

829 The [UML] class diagram describes the payloads for the EiContract service operations.

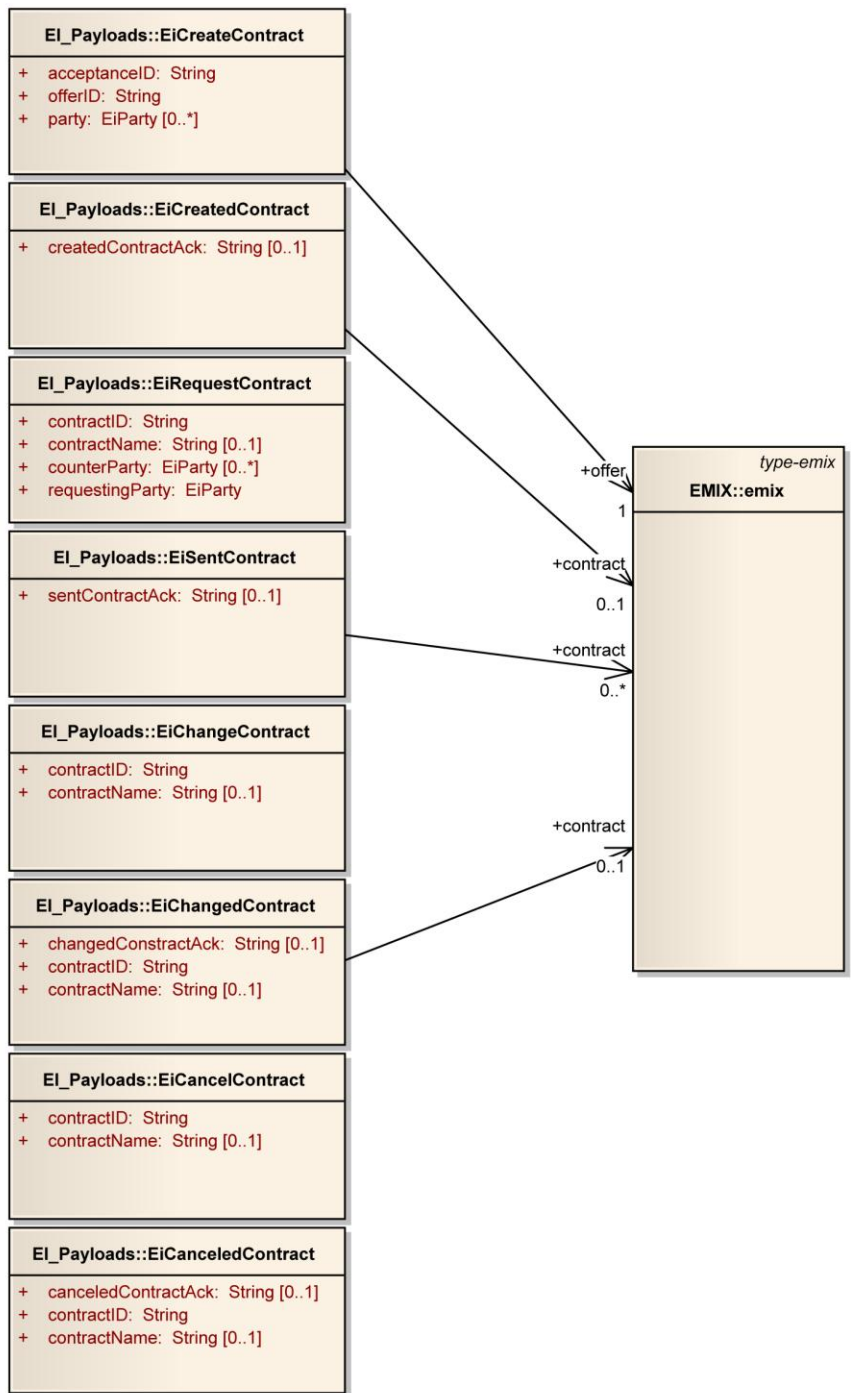

830

831

Figure 7-5: UML Class Diagram of EiContract Service Operation Payloads

832 **7.4 Post-Contract Services**

833 In a market of pure transactive energy, verification would be solely a function of meter readings. The seed
834 standard for smart grid meter readings is the NAESB Energy Usage Information [NAESB EUI]
835 specification.

836 In today’s markets, with most customers on Full Requirements contracts (or tariffs), the situation is
837 necessarily more complex. Full Requirements describes the situation where purchases are not committed
838 in advance. The seller is generally obligated to provide all that the buyer requires. Full requirements
839 contracts create much of the variance in today’s DR markets.

840 As the Full Requirements Verification necessarily incorporates the Energy Usage Information exchange,
841 this section first addresses EUI.

842 These sections will apply the results of the SGIP Priority Action Plan 10 standard (when ratified) along
843 with [WS-Calendar], and are all TBD pending ratification of [NAESB EUI]. The NAESB Measurement
844 and Verification Business Practice will also be considered.

845 **7.4.1 Energy Usage Information**

846 These operations create, change, and allow exchange of Energy Usage Information. TBD pending
847 ratification of [NAESB EUI]

848 *Table 7—5: Energy Usage Information*

Service	Operation	Response	Service Consumer	Service Provider	Notes
EiUsage	EiCreateUsage	EiCreatedUsage	Either	Either	
EiUsage	EiChangeUsage	EiChangedUsage	Either	Either	
EiUsage	EiCancelUsage	EiCanceledUsage	Either	Either	Cancel measurement request
EiUsage	EiRequestUsage	EiSentUsage	Either	Either	

849

850 **7.4.1.1 Information Model for the EiUsage Service**

851 **7.4.1.2 Operation Payloads for the EiUsage Service**

852 The [UML] class diagram describes the payloads for the EiUsage service operations.

853 **7.4.2 Full Requirements Verification**

854 Full requirements verification involves a combination of usage and load measurement and information
855 exchange; contracts often include demand charges (also called demand ratchets) that affect cost. TBD
856 pending ratification of [NAESB EUI]

857 **7.4.2.1 Information Model for the Full Requirements Verification Service**

858 **7.4.2.2 Operation Payloads for the Full Requirements Verification Service**

859 The [UML] class diagram describes the payloads for the *EiFullRequirementsVerification* service
860 operations.

861 8 Event Services

862 8.1 EiEvent Service

863 The Event Service is used to call for performance under a contract. The service parameters and event
864 information distinguish different types of events. Event types include reliability events, emergency events,
865 and more—and events MAY be defined for other actions under a Contract. For transactive services, two
866 parties may enter into a call option. Invocation of the call option by the Promissee on the Promisor can
867 be thought of as raising an event. But typically the Promissee may raise the event at its discretion as long
868 as the call is within the terms of the call option Contract.

869 An ISO that has awarded an ancillary services contract to a party may issue dispatch orders, which can
870 also be viewed as events. In this standard, what historically is called a *price event* is communicated using
871 the EiSendQuote operation (see 7.2 “Pre-Contract Services”).

872 Table 8—1: Event Services

Service	Operation	Response Operation	Service Consumer	Service Provider	Notes
EiEvent	EiCreateEvent	EiCreatedEvent	VTN	VEN	Create invokes a new event
EiEvent	EiChangeEvent	EiChangedEvent	VTN	VEN	
EiEvent	EiCancelEvent	EiCanceledEvent	VTN	VEN	
EiEvent	EiRequestEvent	EiSentEvent	Either	Either	

873 Since the event is the core Demand Response information structure, we begin with Unified Modeling
874 Language [UML] diagrams for the EiEvent class and for each of the operation payloads.

875 8.1.1 Information Model for the EiEvent Service

876 The key class is EiEvent, which has associations with the classes Location, EventInfo, Sequence (from
877 [WS-Calendar]), and Program. See the figure below.

878 An event has certain information including

- 879 • A schedule (and a reference to the schedule)—attributes *schedule* and *scheduleGluonRef*. (Note:
880 a Schedule includes 1 or more intervals, each of which could have a different program level,
881 price, or whatever other information is being communicated by this Event.)
- 882 • An identifier for the event—*eventID*
- 883 • The program or agreement under which the event was issued—*program*
- 884 • A modification counter, a timestamp for the most recent modification, and a reason—
885 *modificationNumber*, *modificationDateTime*, and *modificationReason*
- 886 • A location to which the event applies—*location*—which may be a geospatial location [OGC], an
887 address [UBL], or grid electrical coordinates.
- 888 • Baseline value and a timestamp for that value, used to compare curtailment and “normal”
889 usage—*energyBaselineValue* and *energyBaselineTimestamp*
- 890 • Information on status, comments, and other information—*notificationAcknowledgement*,
891 *operatingDay*, *performanceComment*, *reportingInterval*, *responseValue*, *status*, and *vtnComment*

892

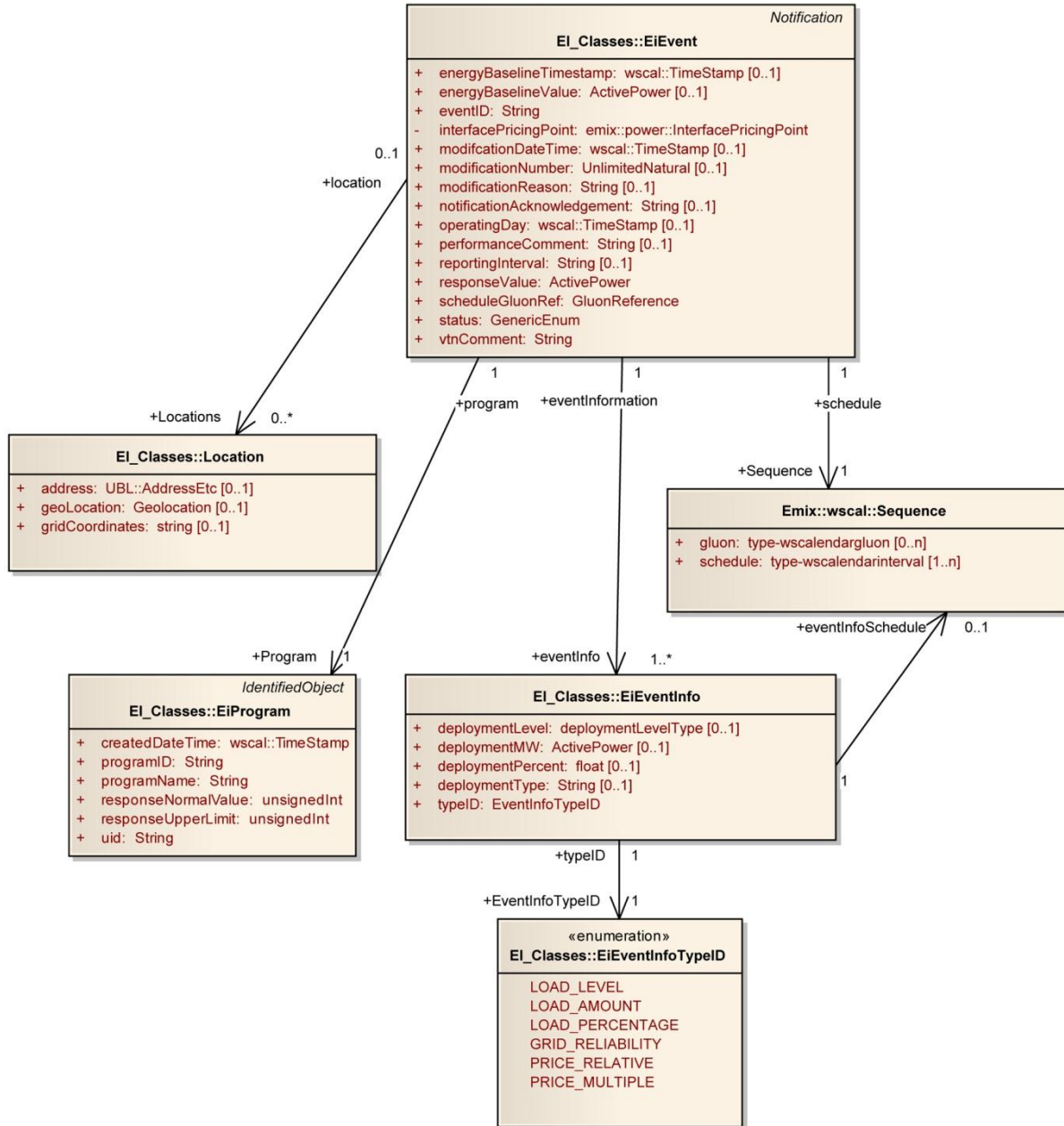

893
894

Figure 8-1: UML Class Diagram for the EiEvent and Associated Classes

895 **8.1.2 Operation Payloads for the EiEvent Service**

896 The [UML] class diagram describes the payloads for the EiEvent service operations.

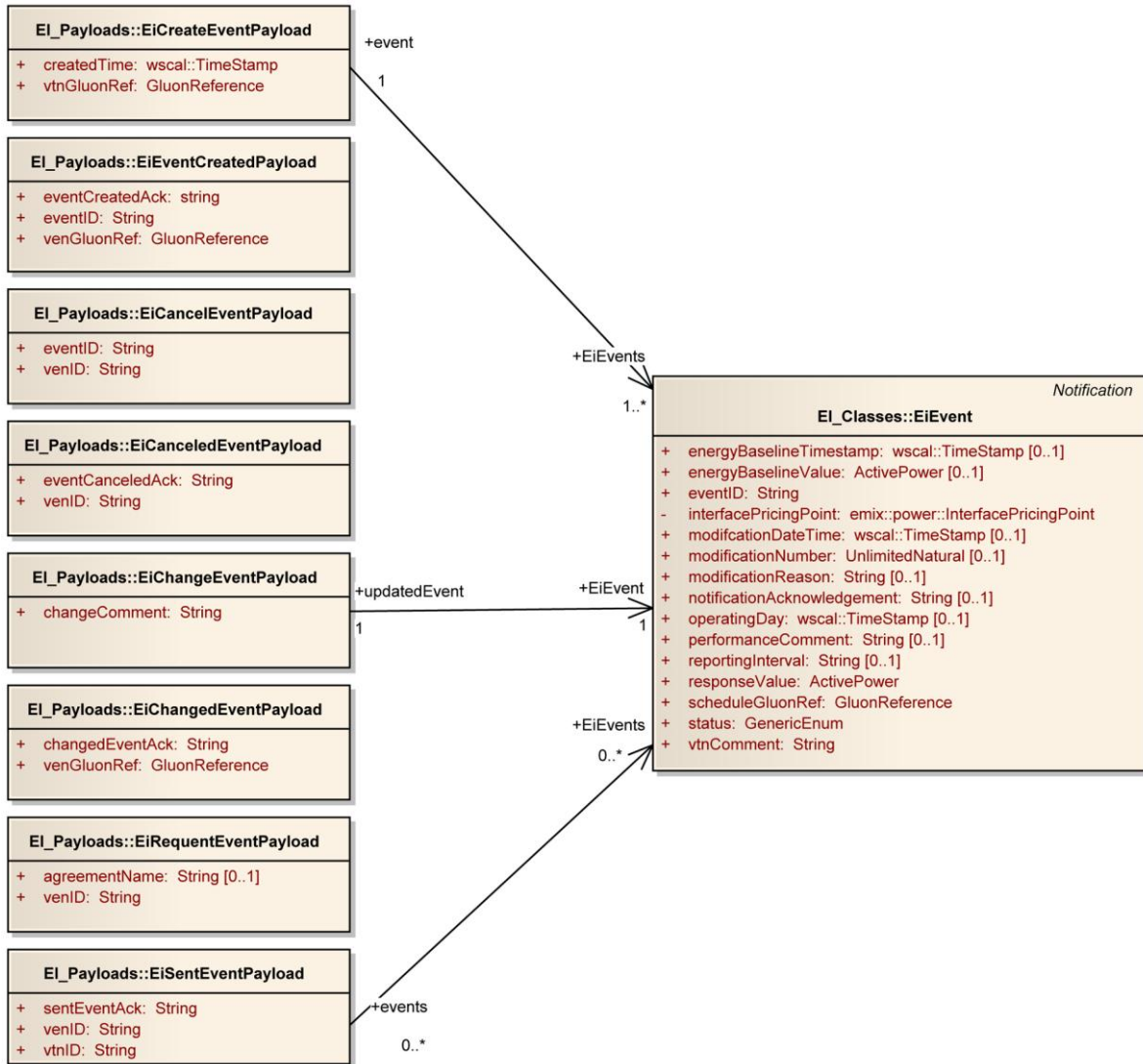

897

898

Figure 8-2: UML Class Diagram for EiEvent Service Operation Payloads

899

900 **8.2 Feedback Service**

901 Feedback communicates provides information about the state of the Asset or Resource as it responds to
 902 a DR Event signal. This is distinct from Status, which communicates information about the state of the
 903 Event itself. See section 9.3 “Status Service” for a discussion of Status.

904 EiFeedback operations are independent of EiEvent operations in that they can be requested at any time
 905 independent of the status or history of EiEvents.

906 *Table 8—2: Feedback Service*

<i>Service</i>	<i>Operation</i>	<i>Response</i>	<i>Service Consumer</i>	<i>Service Provider</i>	<i>Notes</i>
EiFeedback	EiCreateFeedback	EiCreatedFeedback	VTN	VEN	
EiFeedback	EiCancelFeedback	EiCanceledFeedback	VTN	VEN	
EiFeedback	EiRequestResponseSched	EiSentResponseSched	VTN	VEN	

907 **8.2.1 Information Model for the EiFeedback Service**

908 EiFeedback is requested by the VTN and supplied by the VEN(s).

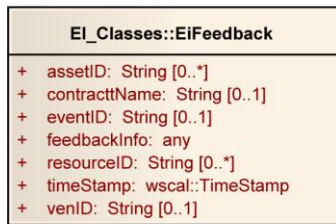

909
 910

Figure 8-3: UML Class Diagram for the EiFeedback Class

911 **8.2.2 Operation Payloads for the EiFeedback Service**

912 The [UML] class diagram describes the payloads for the EiFeedback service operations.

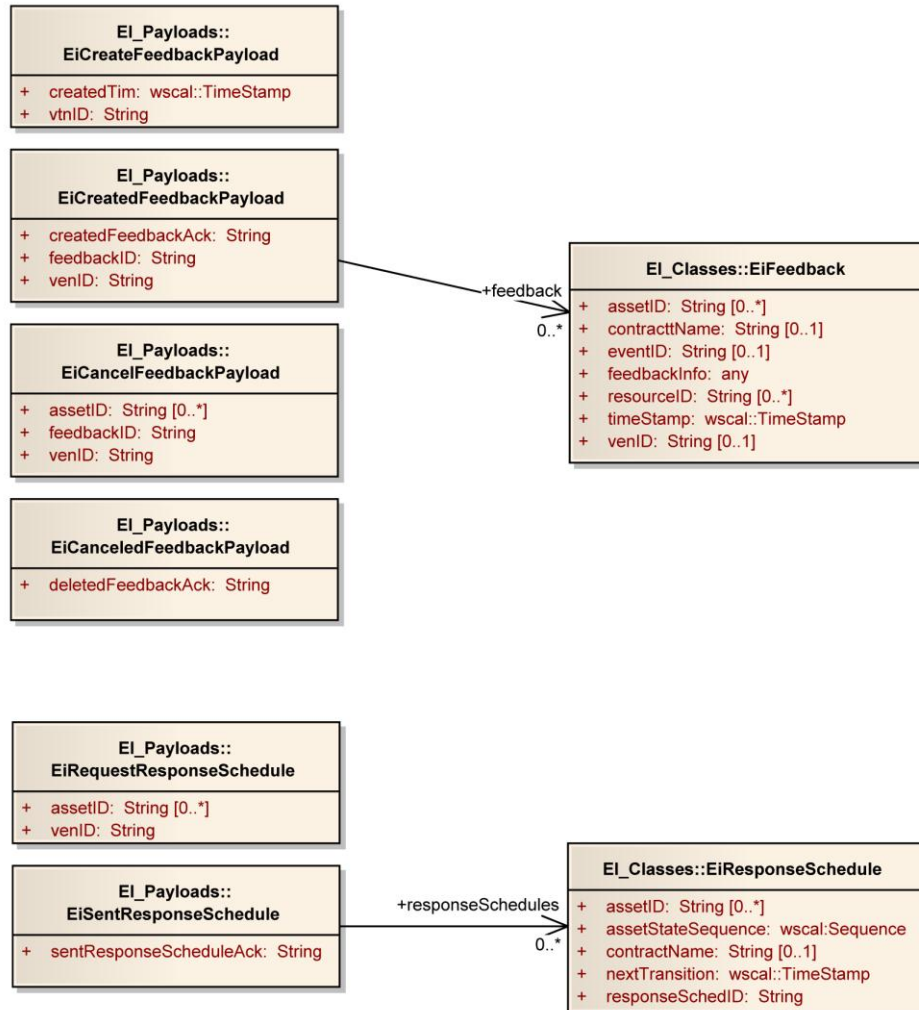

913

914 *Figure 8-4: UML Class Diagram for EiFeedback Service Operation Payloads*

915 **8.3 EiProgram Service**

916 The EiProgram service distributes Program Calls, which are simple levels for requested action. The levels
 917 are purely nominal, and are structured so that any program with *N* levels of requested response can be
 918 represented easily and mapped to and from.

919 This is analogous to the EiQuote service, used for communicating full [EMIX] price and product definition
 920 quotes.

921 Programs for demand response vary considerably. One area of variation is in how many levels of
 922 requested response are defined, and what they are called. The EiProgram services maps any number of
 923 nominal levels to a simple numeric model, allowing the same equipment to function in programs with any
 924 number of levels, and with optional application level mapping (outside the scope of this standard) for
 925 display or other purposes.

926 Some examples of programs and levels are

- 927 • OpenADR—Four levels, Low, Moderate, High, Special [emergency]
- 928 • Smart Energy Profile 2—Three levels, Low, Moderate, High
- 929 • EPA Energy Star 2.0 Interfaces—Four levels, Green, Amber, Orange, Red

930 *EiRequestProgram* and *EiSentProgram* respectively request and send Program Metadata, which in this
 931 version of this standard includes the number of levels (*responseUpperLimit*, with the lower limit always
 932 being the integer one) and the so-called *normal* level (*responseNormalValue*, which must be in 1 to the
 933 *responseUpperLimit* inclusive). Not all programs will assume an ordering, and instead may use purely
 934 nominal levels, in which case *responseNormalValue* will be of limited use.

935 Program Calls ["ProgCalls"] are communicated from a VTN to a VEN or by broadcast.⁸

936 *Table 8—3: EiProgram Service*

<i>Service</i>	<i>Operation</i>	<i>Response</i>	<i>Service Consumer</i>	<i>Service Provider</i>	<i>Notes</i>
EiProgram	EiRequestProgram	EiSentProgram	VEN	VTN	Gets selected Program metadata
EiProgram	EiCreateProgCall	EiCreatedProgCall	Party	Party	And sends the Call
EiProgram	EiCancelProgCall	EiCanceledProgCall	Party	Party	
EiProgram	EiRequestProgCall	EiSentProgCall	Party	Party	Request outstanding Calls (pull)
EiProgram	EiDistributeProgCall	--	Party	Party	For broadcast or distribution of Calls (push)

937

⁸ A negotiation on program levels communicated and understood might be a useful extension, perhaps defaulting to three levels.

938 **8.3.1 Information Model for the EiProgram Service**

939 The key class is EiProgram, which has associations with the classes Location, EventInfo, Sequence (from
 940 [WS-Calendar], and Program. See the figure below.

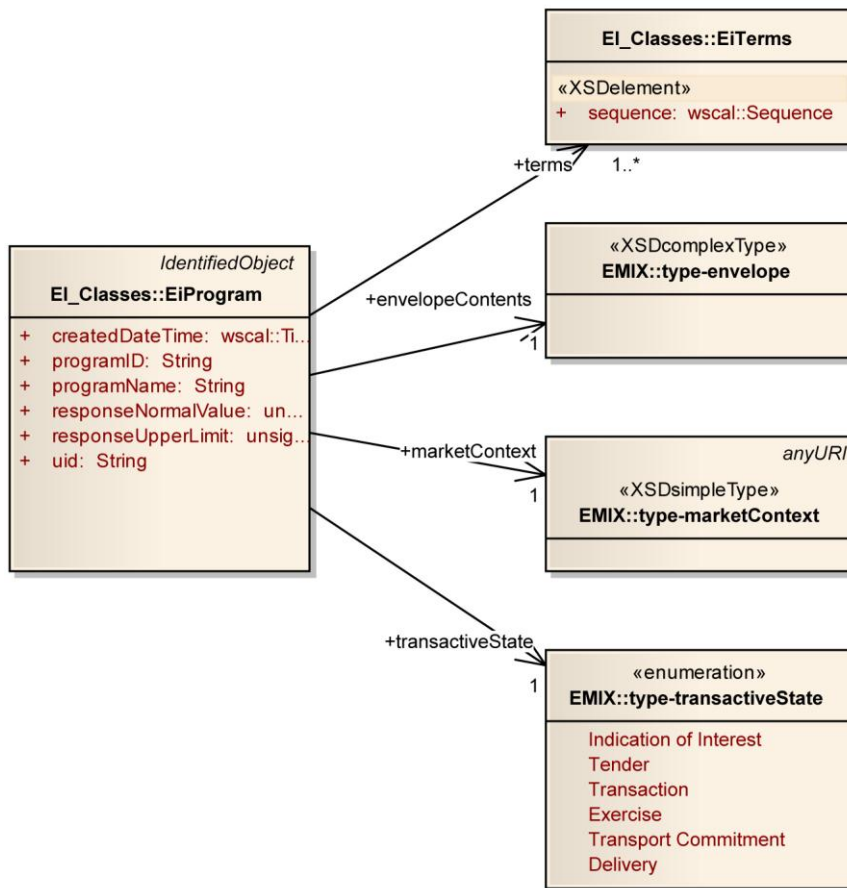

941

942

Figure 8-5: UML Class Diagram for the EiProgram Class

943 **8.3.2 Operation Payloads for the EiProgram Service**

944 The [UML] class diagram describes the payloads for the EiProgram service operations.

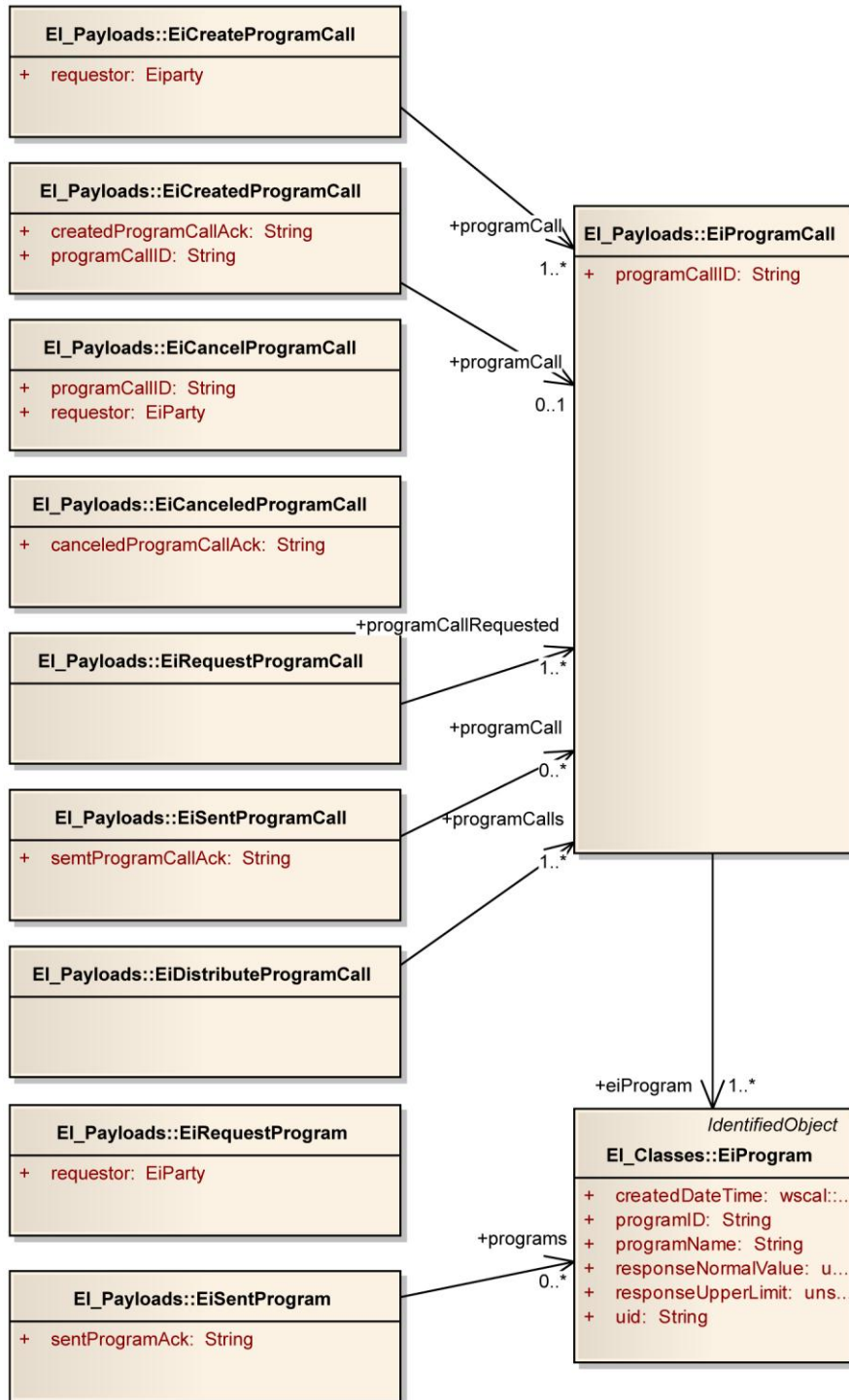

945 *Figure 8-6: UML Class Diagram for EiProgram Service Operation Payloads*

946
947

948 9 Support Services

949 Users of **[OpenADR]** found that they needed to be able to constrain the application of remote DR
 950 services. For The DR Operator, advanced knowledge of these constraints improved the ability to predict
 951 results. The services in this schedule are based on the services used to tailor expectations in
 952 **[OpenADR]**.

953 Constraints and OptOut are similar in that they communicate when an event will *not* be acted upon.
 954 Constraints are long-term restrictions on response and are often at registration or Contract negotiation;
 955 OptOut is a short-term restriction on likely response.

956 The combination of Constraints and OptOut state together (a logical *or*) defines the committed response
 957 from the VEN.

958 Constraints and OptOut apply to curtailment and DER interactions, and only indirectly to price distribution
 959 interactions.

960 9.1 EiConstraint Service

961 Constraints are set by the VEN and indicate when an event may or may not be accepted and executed by
 962 that VEN. The constraints (and OptOut schedules) for its VENs help the VTN estimate response to an
 963 event or request.

964 Constraints are a long-term availability description and may be complex. The next section describes
 965 OptOut and how opting out affects predicted behavior.

966 When constraints are set, opting in or out does not affect the constraints—opting out is temporary
 967 unavailability, which may have contract consequences if an event is created during the optout period.

968 The modeling for constraints includes attributes such as blackout intervals, valid intervals, and behavior
 969 indications for the situation where an EiEvent overlaps a constrained time interval.

970 *Table 9—1: Constraint Service*

Service	Operation	Response	Service Consumer	Service Provider	Notes
EiConstraint	EiCreateConstraint	EiCreatedConstraint	VEN	VTN	
EiConstraint	EiChangeConstraint	EiChangedConstraint	VEN	VTN	
EiConstraint	EiDeleteConstraint	EiDeletedConstraint	VEN	VTN	
EiConstraint	EiRequestConstraint	EiSentConstraint	VEN	VTN	To ensure that the VTN constraints match the VEN description or for recovery

971 The class EiConstraintBehavior defines how an issued EiEvent that conflicts with the current EiConstraint
 972 is performed:

- 973 • ACCEPT – accept the issued EiEvent regardless of conflicts with the EiConstraint
- 974 • REJECT – reject any EiEvent whose schedule conflicts with the EiConstraint
- 975 • **FORCE – regardless of what the issued DR events parameters are (even if there is no conflict)**
 976 **force them to be the parameters that were configured as part of the program.⁹**
- 977 • RESTRICT – modify the EiEvent parameters so that they fall within the bounds of the
 978 EiConstraint

⁹ This will require further definition in a future draft when Program metadata is defined.

9.1.1 Information Model for the Constraint Service

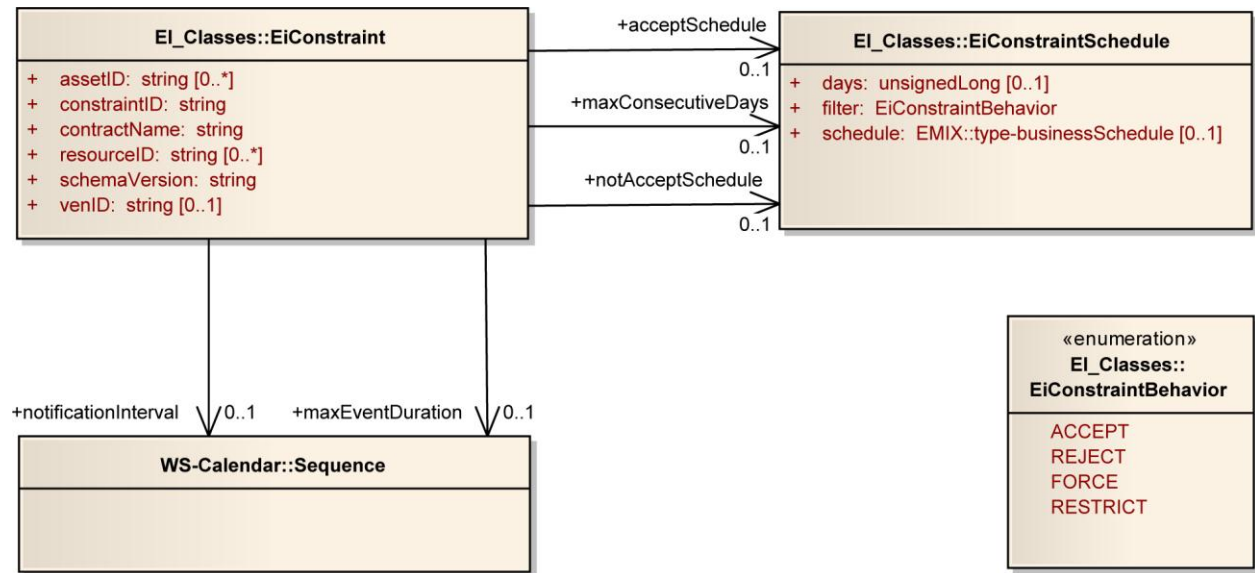
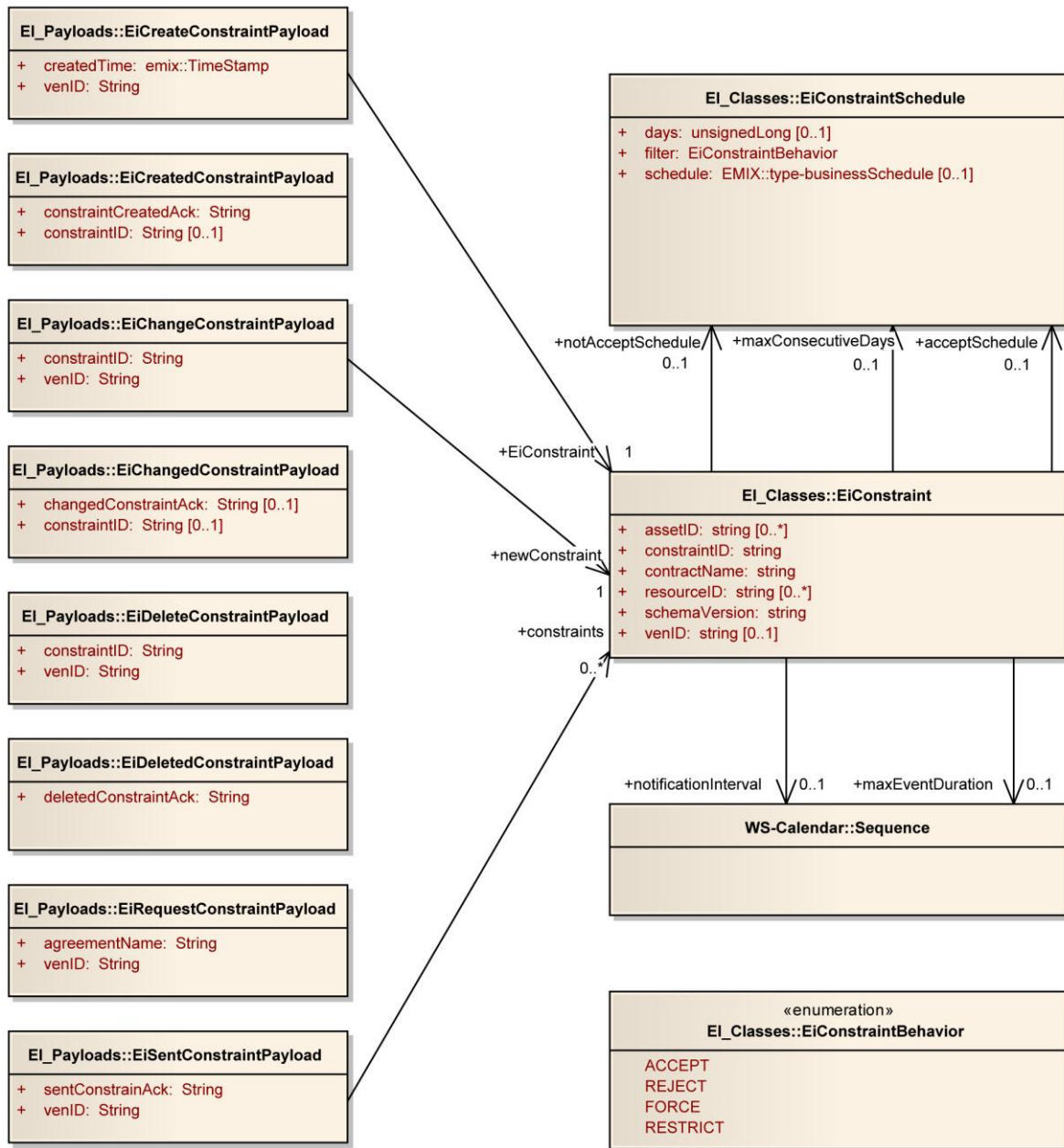

Figure 9-1: UML Class Diagram for the EiConstraint and Associated Classes

982 **9.1.2 Operation Payloads for the EiConstraint Service**

983 The [UML] class diagram describes the payloads for the EiConstraint service operations.



984
985 *Figure 9-2: UML Class Diagram for EiConstraint Service Operation Payloads*

986 **9.2 Opt Out Service**

987 The Opt Out service creates and communicates Opt Out schedules from the VEN to the VTN. Optout
988 schedules are combined with EiConstraints to give a complete picture of the willingness of the VEN to
989 respond to EiEvents that may be created by the VTN.

990

Table 9—2: Opt-Out Service

Service	Operation	Response	Service Consumer	Service Provider	Notes
EiOptout	EiCreateOptoutState	EiCreatedOptoutState	VEN	VTN	
EiOptout	EiChangeOptoutState	EiChangedOptoutState	VEN	VTN	
EiOptout	EiDeleteOptoutState	EiDeletedOptoutState	VEN	VTN	
EiOptout	EiRequestOptoutState	EiSentOptoutState	VEN	VTN	

991 **9.2.1 Information Model for the Opt Out Service**

992 Opt Out is a temporary situation indicating that the VEN will not respond to a particular event or in a
 993 specific time period, without changing the potentially complex Program Constraints. The *EiOptout*
 994 schedule is an **[EMIX]** *businessSchedule*. In comparison the *EiConstraint* class uses two such
 995 *businessSchedules*, one to indicate when a scheduled *EiEvent* is acceptable and another to indicate
 996 when a scheduled *EiEvent* is not acceptable.

997 The *EiOptout* model is in a sense only one half of the constraint model—the *businessSchedule* describes
 998 when a scheduled *EiEvent* is *not* acceptable to the VEN.

999

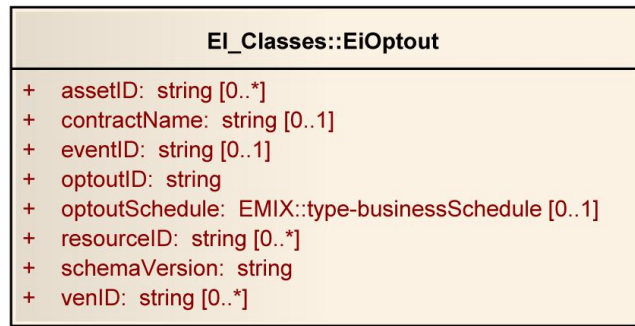

Figure 9-3: UML Class Diagram for the EiOptout Class

1000

1001

1002 **9.2.2 Operation Payloads for the Opt Out Service**

1003 The [UML] class diagram describes the payloads for the EiOptout service operations.

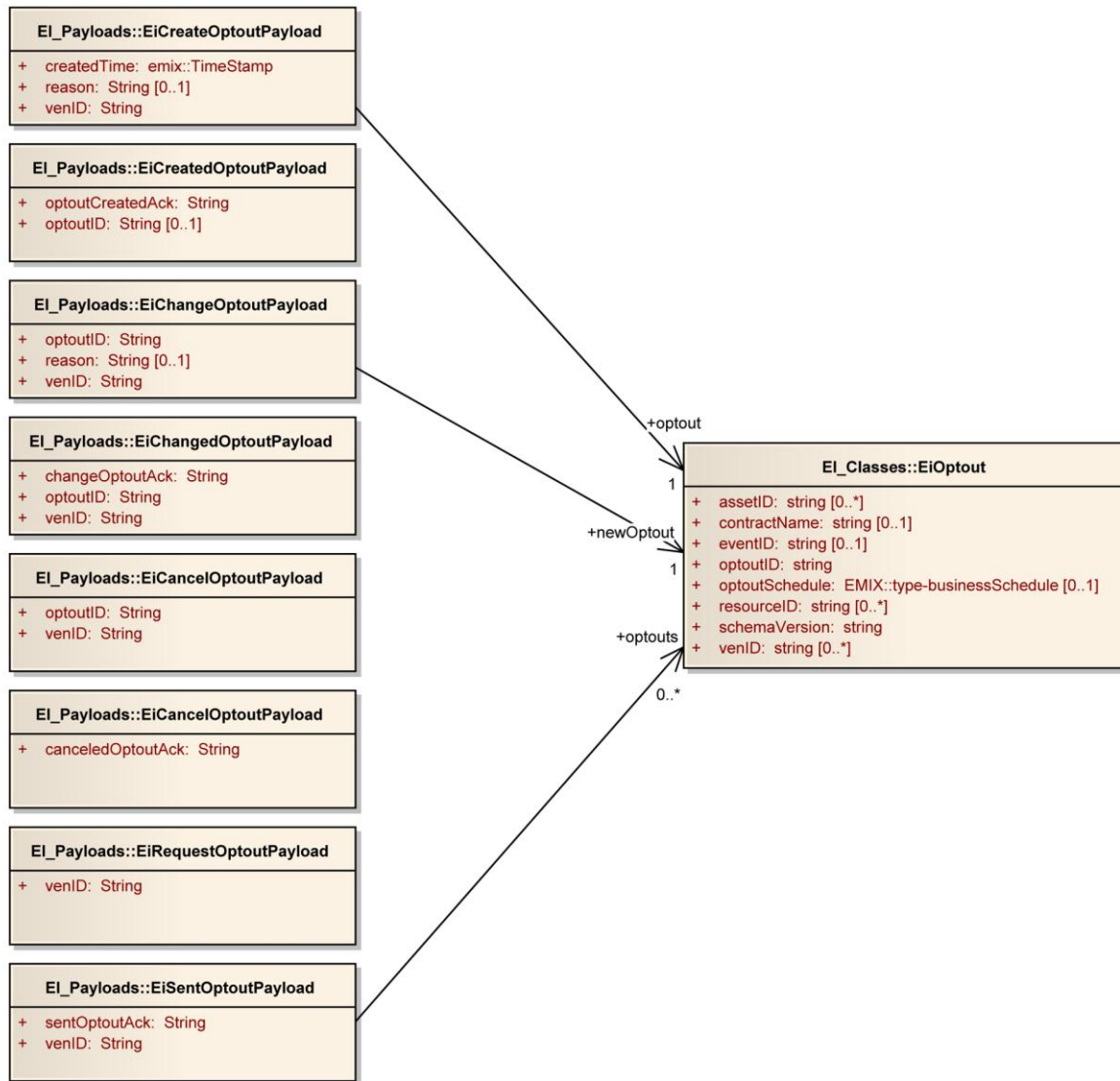

1004

1005

Figure 9-4: UML Class Diagram for EiOptout Service Operation Payloads

1006

1007 **9.3 Status Service**

1008 Status communicates information about the state of an Event itself. This is distinct from Feedback which
 1009 communicates information about the state of Assets or Resources as it responds to a DR Event signal.
 1010 See section 8.2 *Feedback Service* for a discussion of Feedback.

1011 This service requests information held by the VTN. The operation EiRequestStatus requests status for
 1012 each *EiAsset* associated with a given VEN.

1013 *Table 9—3: Status Services*

Service	Operation	Response	Service Consumer	Service Provider	Notes
EiStatus	EiRequestStatus	EiSentStatus	VEN	VTN	Status of Assets associated with a VEN

1014

1015 **9.3.1 Information Model for the Status Service**

1016

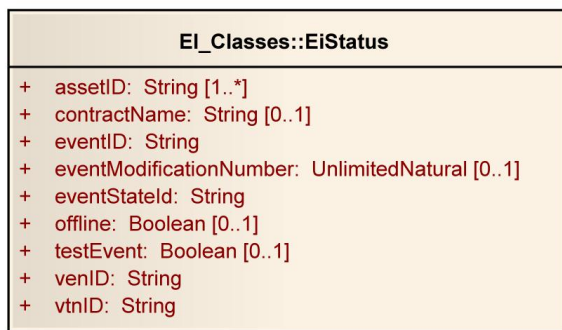

1017

1018 *Figure 9-5: UML Class Diagram for the EiStatus Class*

1019 **9.3.2 Operation Payloads for the Status Service**

1020 The [UML] class diagram describes the payloads for the EiStatus service operations.

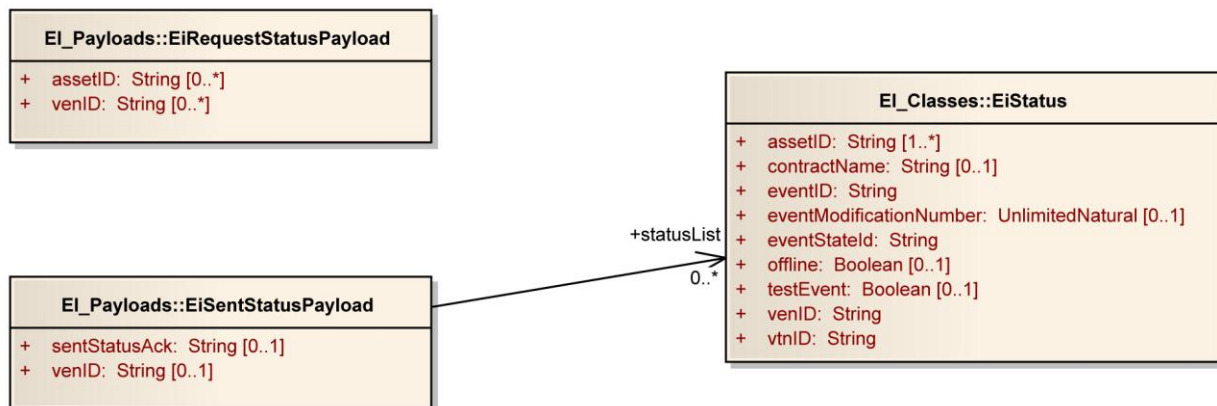

1021

1022 *Figure 9-6: UML Class Diagram for EiStatus Service Operation Payloads*

1023

10 Conformance

1024 *Up until this draft, the core services and payloads have been changing too often for the committee to*
1025 *focus closely on conformance issues. For Interoperability on the scale of the grid, the conformance*
1026 *requirements require the inputs from a wide range of perspectives and approaches. The Technical*
1027 *Committee especially welcomes suggestions and requirements for conformance.*

1028 The SGIP SGTCC has just released v1.0 of their Interoperability Process Reference Manual:
1029 http://collaborate.nist.gov/twiki-sggrid/pub/SmartGrid/SGTCCIPRM/SGTCC_IPRM_Version_1.0.pdf

1030 In section 2 they state,

1031 In the context of interoperability, product certification is intended to provide high confidence that a
1032 product, when integrated and operated within the Smart Grid, will function as stated under
1033 specific business conditions and / or criteria. The IPRM defines criteria, recommendations, and
1034 guidelines for product interoperability and conformance certification. It is important to understand
1035 "Interoperability" has no meaning for a single product but for a relationship among two or more
1036 products. Alternatively, conformance does have meaning for one product as it applies to its
1037 meeting the requirements of the standard or test profile.

1038 Section 5 of the IPRM v1.0 further states that conformance testing precedes Interoperability testing, and
1039 is part of it.

- 1040 • conformance testing is a part of the interoperability testing process (per line 175 of the IPRM
1041 v1.0)
- 1042 • Line 187 states "Prior to interoperability testing, a product is tested for conformance to the
1043 specification at each relevant OSI layer."
- 1044 • Line 203 "conformance testing is in general "orthogonal", or separate from interoperability testing.
1045 Nevertheless, conformance and interoperability testing are interrelated in a matrix relationship."

1046 This specification cannot provide complete conformance requirements for all implementations.
1047 Implementations built upon Energy Interoperation will need to develop their own conformance profiles.
1048 For example, different implementations will support a different mix of business-to-business and business-
1049 to-consumer, with quite different privacy requirements. Each will require its own security, message
1050 requirements (what part of EI to implement), and what other standards are included.

1051 Conformance testing requires that any product that claims to implement EI (as detailed in its PICS
1052 statement, which might indicate a limited set of services), can in fact implement these services according
1053 to the standard, correctly forming each supported service request, and consuming responses, producing
1054 responses as needed, with acceptable parameters, and failing in appropriate and defined ways when
1055 presented with bad data.

1056 The Technical Committee welcomes comments that point to testing and conformance standard or that
1057 discuss the roles of those standards in an interoperability testing process. The Technical Committee also
1058 welcomes suggestions for the organization that should be the Interoperability Testing and Certification
1059 Authority for Energy Interoperation.

1060

A. Background and Development history

1061 There is a significant disconnect between customer load and the value of energy. The demand is not
1062 sensitive to supply constraints; the load is not elastic; and the market fails to govern consumer behavior.
1063 In particular, poor communications concerning high costs at times of peak use cause economic loss to
1064 energy suppliers and consumers. There are today a limited number of high demand periods (roughly ten
1065 days a year, and only a portion of those days) when the failure to manage peak demand causes immense
1066 costs to the provider of energy; and, if the demand cannot be met, expensive degradations of service to
1067 the consumer of energy.

1068 As the proportion of alternative energies on the grid rises, and more energy comes from intermittent
1069 sources, the frequency and scale of these problems will increase and there will be an increasing need for
1070 24/7 coordination of supply and demand. In addition, new electric loads such as electric vehicles will
1071 increase the need for electricity and with new load characteristics and timing.

1072 Energy consumers can use a variety of technologies and strategies to shift energy use to times of lower
1073 demand as well as to reduce use during peak periods. This shifting and reduction can reduce the need for
1074 new power plants, and transmission and distribution systems. These changes will reduce the overall
1075 costs of energy through greater economic efficiency. This process is known by various names, including
1076 load shaping, demand shaping, and demand response (DR). Consistent interfaces and messages for DR
1077 is a high priority cross-cutting issue identified in the NIST Smart Grid Interoperability Roadmap.

1078 Distributed energy resources, including generation and storage, now challenge the traditional hierarchical
1079 relationship of supplier and consumer. Alternative and renewable energy sources may be located closer
1080 to the end nodes of the grid than traditional bulk generation, or even within the end nodes. Wind and solar
1081 generation, as well as industrial co-generation, allow end nodes to sometimes supply. Energy storage,
1082 including mobile storage in plug-in hybrid vehicles, means that even a device may be sometimes a
1083 supplier, sometime a customer. As these sources are all intermittent, they increase the challenge of
1084 coordinating supply and demand to maintain the reliability of the electric grid. These assets, and their
1085 problems, are generally named distributed energy resources (DER). The NIST Smart Grid Interoperability
1086 Roadmap sees a continuum between DR and DER.

1087 Better communication of energy prices addresses growing needs for lower-carbon, lower-energy
1088 buildings, net zero-energy systems, and supply-demand integration that take advantage of dynamic
1089 pricing. Local generation and local storage require that the consumer (in today's situation) make
1090 investments in technology and infrastructure including electric charging and thermal storage systems.
1091 People, buildings, businesses and the power grid will benefit from automated and timely communication
1092 of energy pricing, capacity information, and other grid information.

1093 Consistency of interface for interoperation and standardization of data communication will allow
1094 essentially the same model to work for homes, small businesses, commercial buildings, office parks,
1095 neighborhood grids, and industrial facilities, simplifying interoperation across the broad range of energy
1096 providers, distributors, and consumers, and reducing costs for implementation.

1097 These communications will involve energy consumers, producers, transmission systems, and distribution
1098 systems. They must enable aggregation of production, consumption, and curtailment resources. These
1099 communications must support market makers, such as Independent System Operators (ISOs), utilities,
1100 and other evolving mechanisms while maintaining interoperation as the Smart Grid evolves. On the
1101 consumer side of these interfaces, building and facility agents will be able to make decisions on energy
1102 sale, purchase, and use that fit the goals and requirements of their home, business, or industrial facility.

1103 The new symmetry of energy interactions demands symmetry of interaction. A net consumer of energy
1104 may be a producer when the sun is shining, the wind is blowing, or an industrial facility is cogenerating¹⁰.
1105 Each interface must support symmetry as well, with energy and economic transactions able to flow each
1106 way.

¹⁰ Cogeneration refers the combined generation of multiple energy resources, i.e., a boiler that both spins a turbine to generate electricity and produces steam to run an industrial process. Cogeneration can include any number of energy distributions, including heat, cold, pressure, et al.

1107 Energy Interoperation defines the market interactions between smart grids and their end nodes
1108 (Customers), including Smart Buildings and Facilities, Enterprises, Industry, Homes, and Vehicles. Market
1109 interactions are defined here to include all informational communications and to exclude direct process
1110 control communications. This document defines signals to communicate interoperable dynamic pricing,
1111 reliability, and emergency signals to meet business and energy needs, and scale, using a variety of
1112 communication technologies.

1113

B. Collaborative Energy

1114 Collaborative energy relies on light coupling of systems with response urgency dictated by economic
1115 signals. Customers are able to respond as little or as aggressively as they want. “Every brown-out is a
1116 pricing failure.”

1117 Because collaborative energy requires no detailed knowledge of the internal systems of the end nodes, it
1118 is indifferent to stresses caused by changes in technology within the end node, and is more accepting of
1119 rapid innovation

1120 Because collaborative energy offers economic rewards without loss of autonomy, end nodes may seek to
1121 maximize their economic opportunities. Collaborative energy creates a market for end-node based
1122 technologies to save, store, or generate electricity on demand.

1123 Collaborative energy signals are results oriented signals and are agnostic about technology. Light, loose
1124 integrations based on service-oriented signals adopt enterprise best practices.

B.1 Collaborative Energy in Residences

1126 It is a long-held dictum that residences were unable to participate effectively in price-based demand
1127 response. The groundbreaking Olympic Peninsula Project disproved that assumption, as homeowners
1128 were able to better reduce energy usage and respond to local congestion when responding to price
1129 signals than were homes under managed energy.

1130 The Olympic Peninsula Project was distinguished from a traditional managed energy project by its smart
1131 thermostat and meter. Direct control of building systems using managed energy approaches were
1132 transferred from the managing utility to the thermostat. Price signals and an innovative user interface then
1133 transferred autonomy and decision-making to the homeowner.

B.2 Collaborative Energy in Commercial Buildings

1135 Larger commercial buildings have long had the intelligent infrastructure necessary for collaborative
1136 energy. Large buildings have custom control systems, often based on PCs. These custom control
1137 systems make commercial ideal candidates for collaborative energy.

1138 The growth of collaborative energy in commercial buildings will be stimulated the sharing of live usage
1139 and price information.

B.3 Collaborative Energy in Industry

1141 It is often expensive for an industrial site to curtail significant load on short notice. Industrial processes are
1142 characterized by long run times and large, if predictable, energy use. Industrial sites are not a primary
1143 focus of DR.

1144 Industrial sites do have three means of participating in collaborative energy. (1) They can schedule those
1145 long running processes in advance. (2) Because of their scale, industrial sites can manage the shape of
1146 their load, balancing internal processes. (3) Industrial sites are often supported by combined heat and
1147 power plants that can be assets to a stressed grid.

1148 Collaborative energy scheduling in industrial sites requires that the plant operators know the energy
1149 profile of long-running processes. The site operators can then request bids that energy profile on various
1150 schedules. Using price signals, the supplier can influence when those processes occur. This allows large-
1151 scale load shifting and improves the suppliers' ability to estimate loads.

1152 Within a large facility, there may be many motors, and many different environmental systems. Such loads
1153 are episodic, using lot so energy when running, and none when they are not. Large energy customers are
1154 often charged for peak load, as well as for overall energy use. Operators can coordinate systems so that
1155 energy spikes from different systems do not coincide.

1156 This sort of load shaping becomes more important as the operating safety margins of the grid become
1157 less. While load shaping may cause some inconvenience at any time, it is much more valuable to supplier

1158 during peak energy events on the grid. Differential pricing by time or dynamic pricing for load spikes as
1159 well as overall load size can aid in grid stability. Time differential pricing of usage spikes can also
1160 encourage shifting of overall load, as the convenience of daytime operations is offset by the convenience
1161 ignoring load shaping.

1162 Generation that produces multiple usable energy streams is known as cogeneration. Combined heat and
1163 power, wherein a facility produces electricity and steam is the most common kind of cogeneration. A
1164 cogeneration facility can often, within limits, vary the output of thermal and electrical energy. Because it
1165 usually has a distribution system for thermal energy, it has the means to store thermal mass. Economic
1166 incentives through collaborative energy give industrial sites the incentives to further develop these
1167 capabilities.

1168 **B.4 Summary of Collaborative Energy**

1169 Collaborative energy relies on intelligence in each end node of the grid. That intelligence is embedded in
1170 systems that understand the particular features of each end node better than a central supplier ever will.
1171 In particular, systems in the end node will better understand the business processes and aspirations of
1172 the occupants of that end node than will the grid.

1173 Collaborative energy response by each end node will be more variable than is managed energy. An end
1174 node may decide whether to participate in any event. The end node may also choose to participate more
1175 fully, as an autonomic decision, in a particular DR event.

1176 If price and risk arbitrage, coupled with obscure regulated accounting, are barriers to the smart grid, the
1177 generative solution includes shared honest, transparent accounting and limiting the interoperation points
1178 and complexity for the smart grid. In other words, we need to treat energy markets more as we treat
1179 financial markets.

1180 Under collaborative energy, service performance matters more than process performance. This reduces
1181 the complexity required at the grid level to manage distributed energy resources (DER). Both generation
1182 and drain-down of storage may be indistinguishable from demand response. Battery filling is just one
1183 more service responding the cheap energy.

1184

C. Glossary

- 1185 No definition in this glossary supplants normative definitions in this or other specifications. They are here
1186 merely to provide a guidepost for readers at to terms and their special uses. Implementers will want to be
1187 familiar with all referenced standards.
- 1188 Agreement is broad context that incorporates market context and programs. Agreement definitions are
1189 out of scope in Energy Interoperation. See Contract.
- 1190 Asset: An end device that is capable of shedding load in response to Demand Response Events,
1191 Electricity Price Signals or other system events (e.g. Under-Frequency Detection). Assets are
1192 under the control of a Resource. A VTN can query an Asset for its state, and call on an Asset for
1193 a response. The Resource mediates all Asset interactions, as per its agreement with the VTN.
1194 Assets are limited to consuming Direct Load Control and Pricing messages. If an Asset has its
1195 own Assets, it does not reveal them to the VEN.
- 1196 Contracts are individual transactions entered into under an Agreement.
- 1197 DR Asset: see Asset
- 1198 EMIX: As used in this document, EMIX objects are descriptions applied to a WS-Calendar Sequence.
1199 EMIX defines Resource capabilities, used in tenders to match capabilities to need, and in
1200 Products, used in tenders and in specific performance and execution calls.
- 1201 Feedback: Information about the state of an Asset or Resource in relation to an Event
- 1202 Resource (as used in Energy Interoperation): a Resource is a logical entity is dispatchable. A Resource
1203 may or may not expose any subordinate Assets. In any case, the Resource is solely responsible
1204 for its own response, and those of its subordinate Assets.
- 1205 Resource (as used in EMIX): A Resource is something that can describe its capabilities in a Tender into a
1206 market. How those Capabilities vary over time is defined by application of the Capability
1207 Description to a WS-Calendar Sequence. See EMIX.
- 1208 Status: Information about an Event, perhaps in relation to an Asset or Resource.
- 1209 Sequence: A set of temporally related intervals with a common relation to some informational artifact as
1210 defined in WS-Calendar. Time invariant elements are in the artifact (known as a gluon) and time-
1211 varying elements are in each interval.
- 1212 VEN – see Virtual End Node
- 1213 Virtual End Node (VEN): The VEN has operational control of a set of resources and/or processes and is
1214 able to control the output or demand of these resources in affect their generation or utilization of
1215 electrical energy intelligently in response to an understood set of smart grid messages. The VEN
1216 may be either a producer or consumer of energy. The VEN is able to communicate (2-way) with a
1217 VTN receiving and transmitting smart grid messages that relay grid situations, conditions, or
1218 events. A VEN may take the role of a VTN in other interactions.
- 1219 Virtual Top Node (VTN): a Party that is in the role of aggregating information and capabilities of
1220 distributed energy resources. The VTN is able to communicate with both the Grid and the VEN
1221 devices or systems in its domain. A VTN may take the role of a VEN interacting with another
1222 VTN.
- 1223 VTN – see Virtual Top Node

1224

D. Acknowledgements

1225 The following individuals have participated in the creation of this specification and are gratefully
1226 acknowledged:

1227 **Participants:**

1228 Hans Aanesen, Individual
1229 Bruce Bartell, Southern California Edison
1230 Timothy Bennett, Drummond Group Inc.
1231 Carl Besaw, Southern California Edison
1232 Anto Budiardjo, Clasma Events, Inc.
1233 Edward Cazalet, Individual
1234 Joon-Young Choi, Jeonju University
1235 Kevin Colmer, California Independent System Operator
1236 Toby Considine, University of North Carolina
1237 William Cox, Individual
1238 Sean Crimmins, California Independent System Operator
1239 Phil Davis, Schneider Electric
1240 Sharon Dinges, Trane
1241 Robert Dolin, Echelon Corporation
1242 Rik Drummond, Drummond Group Inc.
1243 Ernst Eder, LonMark International
1244 Thomas Ferrentino, Individual
1245 Craig Gemmill, Tridium, Inc.
1246 Girish Ghatikar, Lawrence Berkeley National Laboratory
1247 Gerald Gray, Southern California Edison
1248 Anne Hendry, Individual
1249 Thomas Herbst, Cisco Systems, Inc.
1250 David Holmberg, NIST
1251 Gale Horst, Electric Power Research Institute (EPRI)
1252 Ali Ipakchi, Open Access Technology International Inc. (OATi)
1253 Oliver Johnson, Tendril Networks, Inc.
1254 Sila Kiliccote, Lawrence Berkeley National Laboratory
1255 Ed Koch, Akuacom Inc
1256 Michel Kohanim, Universal Devices, Inc.
1257 Larry Lackey, TIBCO Software Inc.
1258 Derek Lasalle, JPMorganChase
1259 Jeremy Laundergan, Southern California Edison
1260 Benoit Lepeuple, LonMark International
1261 Edgardo Luzcando, Midwest ISO and ISO/RTO Council (IRC)
1262 Carl Mattocks, Individual
1263 Dirk Mahling, CPower
1264 Kyle Meadors, Drummond Group Inc.
1265 Scott Neumann, Utility Integration Solutions Inc.
1266 Robert Old, Siemens AG
1267 Mary Ann Piette, Lawrence Berkeley National Laboratory
1268 Donna Pratt, New York ISO and ISO/RTO Council (IRC)
1269 Ruchi Rajasekhar, Midwest Independent System Operator
1270 Jeremy Roberts, LonMark International
1271 Anno Scholten, Individual
1272 Pornsak Songkakul, Siemens AG
1273 Jane Snowdon, IBM
1274 Aaron Snyder, NIST
1275 William Stocker, New York ISO and ISO/RTO Council (IRC)
1276 Pornsak Songkakul, Siemens AG

- 1277 Robert Stayton, Individual
1278 Jake Thompson, EnerNOC
1279 Matt Wakefield, Electric Power Research Institute (EPRI)
1280 Douglas Walker, California Independent System Operator
1281 Evan Wallace, NIST
1282 Dave Watson, Lawrence Berkeley National Laboratory
1283 David Wilson, Trane
1284 Leighton Wolffe, Individual
1285 Brian Zink, New York Independent System Operator
- 1286 The Technical Committee also acknowledges the work of the contributing groups who did so much to
1287 bring requirements and use cases to the attention of the Committee. In particular, the ISO/RTO Council
1288 task force on Demand Response, the UCAIug OpenSG Task Force on OpenADR, and the NAESB Smart
1289 Grid Task Force provided invaluable guidance and frequent feedback.
- 1290 The following individuals have participated in the creation of this specification and are gratefully
1291 acknowledged:
- 1292 **UCAIug OpenSG OpenADR Task Force:**
1293 Albert Chiu, Pacific Gas & Electric
1294 Bruce Bartell, Southern California Edison
1295 Gerald Gray, Southern California Edison
1296
- 1297 **The ISO / RTO Council Smart Grid Standards Project:**
- 1298 We want to thank the IRC team, in particular those who directly participated in this Technical Committee:
1299 Edgardo Luzcando, Midwest ISO and ISO/RTO Council (IRC)
1300 Donna Pratt, New York ISO and ISO/RTO Council (IRC)
1301 William Stocker, New York ISO and ISO/RTO Council (IRC)
- 1302 The IRC team consisted of a large group of participants from ISOs and RTOs. See the IRC Smart Grid
1303 Standards web site for additional details about the project and team members -
1304 http://www.isorto.org/site/c.jhKQIZPBlmE/b.6368657/k.CCDF/Smart_Grid_Project_Standards.htm
1305
- 1306 **NAESB Smart Grid Standards Development Subcommittee Co-chairs:**
1307 Brent Hodges, Reliant
1308 Robert Burke, ISO New England
1309 Wayne Longcore, Consumers Energy
1310 Joe Zhou, Xtensible Solutions

1311

E. Revision History

1312

Revision	Date	Editor	Changes Made
1.0 WD 01		Toby Considine	Initial document, largely derived from OpenADR
1.0 WD 02		Toby Considine	
1.0 WD 03		Toby Considine	
1.0 WD 04		Toby Considine	
1.0 WD 05		Toby Considine	
1.0 WD 06		Toby Considine	
1.0 WD 07		Toby Considine	
1.0 WD 08	2010-03-09	Toby Considine	Reduced core functions to two service groups, transactional energy and eliminated references to managed energy
1.0 WD 09	2010-03-23	Toby Considine	
1.0 WD 10	2010-05-11	William Cox	Updated interaction model per analysis and drawings in TC meetings in April and early May
1.0 WD 11	2010-05-18	William Cox and David Holmberg	Improved model; editorial and clarity changes. Addressed comments on interaction and service model from TC meetings in May 2010.
1.0 WD 12	2010-05-21	William Cox	Editorial and content corrections and updates. Consistency of tone; flagged portions that are more closely related to EMIX.
1.0 WD 13	2010-08-31	Toby Considine Ed Cazalet	Recast to meet new outline, Removed much of the "marketing" content or moved, for now, to appendices. Re-wrote Sections 2, 3. Created placeholders in 4, 5,6 for services definitions.
1.0 WD 14	2010-10-31	William Cox	Completed service descriptions and restructured the middle of the document. Completed the EiEvent service and included UML diagrams. Deleted no longer relevant sections.
1.0 WD 15	2010-11-15	William Cox Toby Considine	Re-wrote sections 5, 7. Re-cast and combined to divergent sections 3. Misc Jira responses
1.0 WD 16	2010-11-18	William Cox	Added missing Section 6
1.0 WD 17	2010-11-22	Toby Considine, William Cox	Responded to many comments, added Program Services, added description of Resources and EMIX and WS-Calendar (4). Added Glossary

1.0 WD 18	2010-11-24	Toby Considine	Responded to formal comments Added additional language on WS-Calendar Incorporated missing ProgramCall Added Simple Market Model to Interactions
-----------	------------	----------------	---

1313