

Publication Process Review Task Force (PPRTF) Report to the Executive Committee

Last reviewed: 3/26/4/2002

Last modified: 3/26/4/2002

–Executive Summary

During the August 2001 GISB Executive Committee Meeting, concern was expressed by some members about the delay between the perceived publication date (June 18, 2001) of GISB Business Practice Standards – Version 1.5 and the actual date the publication materials became available (August 18, 2001). ~~The implementation of certain standards in~~ Version 1.4-5, certain standards stated that the implementation ~~it~~ should occur -9 months following their publication date. The June 18 date was actually the date the last ratification ballot was due and ultimately, an EC motion ~~to~~ declared August 18, 2001 as the official publication date. Two subsequent errata notices to Version 1.5 ~~have were~~ also ~~been~~ posted since the initial publication.

Version 1.5 publication ~~had been was~~ delayed by the EC several times to include a wide variety of standards including those pertaining to Order 637 related work, Title Transfer Tracking and Imbalance Netting & Trading. While well intentioned, these delays, along with the overall cumulative size of the GISB standards documentation work product that had been developed over the years, made publication of Version 1.5 ~~more challenging than some of the other previous versions.~~

As a means to better understand the publication process and to provide guidance for future publications, at its August 23, 2001 meeting, the Executive Committee passed the following motion ~~creating the Publication Process Review Task Force at its August 23, 2001 meeting:~~

Create a publication process review task force charged with examining the existing publication process and suggesting improvements to the process. The task force will report its findings to the ~~executive Executive committee Committee~~ at the October 2001 EC meeting and conclude its work by no later than December 2001.

As a result of its investigation, the PPRTF developed ~~s~~ several sets of flow charts, notes and diagrams detailing existing publication processes and proposed publication processes. These are included in the appendices of this report.

The task force made a conscious effort to work within the existing GISB Operating Procedures (~~GISBopsGISBOPs~~).

The recommendations contained within this report in no way should be seen as a criticism of past publication efforts. The daily use of the internet and other technologies has changed dramatically since the publication of the first version of GISB Business Practice Standards. ~~As a continuous improvement organization, it is logical that, from time to time, those procedures should be reviewed and changed, if warranted. The world and technologies used on a day to day basis have changed dramatically since the publication of the first version of Business Practice Standards.~~

The Task Force sees publication as one of the core responsibilities of the NAESB office; the Standards are the organization's main work product. To implement ~~these the following~~ recommendations, it is critical that office staffing be sufficient to conduct the work at hand. Staffing, as well as the realignment of office responsibilities, are the purview of the Board and Executive Director, respectively. ~~Absent Without changes to the existing processes and~~

increased staffing, ~~given with~~ the incorporation of three additional quadrants, future publication efforts will grow more daunting, if not impossible.

—Recommendations from the PPRTF

- Publication should occur every year- ~~and the best date to publish each year is July 31.~~

~~The best date to publish each year is July 31.~~

- Development ~~and maintenance of~~ Expanded Logs to track requests through the NAESB process ~~from request submission through~~ ~~Publication~~publication.
- ~~Process~~ Minor Clarifications and Corrections ~~should be handled~~ similarly to Request for Standards and Interpretations (i.e., forms & logs).
- Enhancemen~~ts to the~~ Request Numbering system to identify status of a given Request within the standards development process.
- Append~~ing~~ the 'As Approved' Recommendation Forms to the EC meeting minutes.
- Expedite~~d~~ ~~Preparation~~preparation of Meeting Minutes.
- Starting with the July 31, 2002 publication, ~~modify~~ the format and availability of ~~the~~ Contracts Standards manual ~~to be~~ more consistent with other Standards Manuals.
- ~~Make the~~ ~~Creation~~creation of printed Standards Manuals and CDs ~~should be~~ a post-publication process.
- ~~Publish~~ ~~The~~the next set of Standards Manuals ~~as should be published as~~ NAESB - Wholesale Gas Quadrant Version 1.6
- ~~Refer to~~ ~~All~~ Clarifications & Interpretations (e.g., Requests & Recommendations) ~~should only be referred to~~ as 'Interpretations'.
- ~~Conduct~~ ~~More~~more frequent Ratification Votes.
- Move to a "Continuous" publication process.

—Open Issues to be resolved in the next year

- Should there be a universal request numbering system ~~for all quadrants~~?
- Should there be a universal standards/model business practices numbering system?
If so, how are quadrant(s) specific standards indicated?
- ~~Should there be a separate standards/model business practices publication for each quadrant?~~
~~Should there be a separate standards/model business practices publication for each quadrant?~~
If so, should all quadrant publications be issued on the same date?
- Development of criteria for versioning of NAESB Standards Manuals.

—Narrative containing support for each of the specific recommendations

- Publication should occur every year and the best date to publish each year is July 31.
~~Publication should occur every year.~~

~~Based upon past experience...~~ While no GISBOP requiring publications of Standards Manuals on July 31 each year exists, GISB Standards have generally been published around that date each year. Version 1.0 was published on June 14, 1996. Version 1.1 was a significant exception because of its January 31, 1997 publication date. Version 1.2 was published July 31, 1997 resulting in two publications that year. Version 1.3 was published July 31, 1998. Version 1.4 was a less significant departure in that most of it was published one month following the initially scheduled July 31, 1999 date. The EDM Standards Manuals for Version 1.4 were published in November 1999.

Version 1.5 publication was the most significant departure from the annual publication regimen. While the initial publication date was projected as July 31, 2000, the publication date was delayed by the EC to include a wide variety of standards including those pertaining to Order 637 related work, Title Transfer Tracking and Imbalance Netting & Trading. The publication date was actually delayed in steps; each time the intent was that some increment of standards development should be included. The final publication date was approximately a year after the projected date. While well intentioned, these delays, along with the cumulative size of the GISB standards documentation developed over the years, made publication of Version 1.5 challenging.

The paradox of the small delay for publication of Version 1.4 and the larger delay for Version 1.5 is that the number of standards added appears small relative to Version 1.1 or Version 1.2. For more recent publications, as standards are added or modified, a progressively larger amount of resources needs to be dedicated to a review of the existing GISB work product to ensure that no inadvertent conflicts or inconsistencies arise.

Under normal circumstances, two publications would have taken place in the time between the publication of Version 1.4 and Version 1.5. In a simplistic sense, had two publications occurred, the publication team would have had twice as much time (roughly the same calendar period in both 2000 and 2001) to prepare the publications. Prospectively, any departure from a once per year publication regimen should be avoided. The EC needs to be more aware of the lead times involved in the publication process.

~~The best date to publish each year is July 31.~~

The GISB datasets were developed in Data Interchange Standards Association (DISA). As background, DISA is home for the development of cross-industry electronic data interchange standards that provide the foundation to enable individuals, companies and organizations to participate in global e-business. Within DISA, the group that GISB has worked through to develop the EDI datasets is the Accredited Standards Committee (ASC) X12.

Each year, DISA publishes their versions in December. This latest version becomes available during mid-to-late January. Additionally, the company that develops the software used to produce the EDI implementation guides subsequently makes their updated product available a couple months thereafter. In order to ensure that the DISA version and the GISB version are in sync, it is necessary to postpone completion of the EDI portion of the GISB version until the necessary software is available.

~~A July 31 publication date syncs up with ANSI.~~

- Develop and maintain Expanded Logs to track requests through the NAESB process from request submission through publication.

~~Development and maintenance of Expanded Logs to track requests through the NAESB process through Publication.~~

~~The expanded request logs should be developed *and to* include all existing open requests, *however, there.* ~~There~~ is no need to recast *historical* completed requests. The logs should be organized by subject matter (Requests for Standards, Requests for Interpretations, and Requests for Minor Clarifications and Corrections) and then within the subject matter, they should be organized based on the year the request is submitted.~~

~~One of the issues identified by members of ~~t~~The task force ~~was recognized~~ the need/benefit ~~to of have~~ having one place to ~~see~~ track the status of any particular request. Historically, ~~t~~The logs ~~previously~~ posted ~~were updated to~~ reflected the updated status after each subcommittee/taskforce meeting in which is ~~was discussed~~ processing. The recommendation is to expand that functionality by providing status codes, links to ~~meeting~~ minutes and other related documents, thus making the log a dynamic document.~~

- Process Minor Clarifications and Corrections similarly to Request for Standards and Interpretations (i.e., forms & logs).
~~Minor Clarifications and Corrections should be handled similarly to Request for Standards and Interpretations (i.e., forms & logs)~~

~~Historically, Minor Clarifications and Corrections have been brought to the attention of the EC either through an e-mail to the NAESB office from a company or from a subcommittee. The task force recommends *a Request Form* be used for ~~that~~ the submission of ~~the a~~ request for a Minor Clarification and Correction. *This would result in should follow* the same submission procedures *as used for other requests through the use of a Request Forms*. Upon ~~such~~ submission to the NAESB office, ~~should assign it~~ a comparable request number *would be assigned and be prepared* to track the request through use of the Request for Minor Clarifications and Corrections Logs. In so doing, there ~~is would be~~ a consistent tracking system for ~~both use by the NAESBNAESB~~ membership as well as *the personnel responsible for preparing the publication*. In no way does this imply ~~that the incorporation of~~ a more rigorous "17-2" type process ~~as issimilar to that used for~~ used for *processing requests for handling* Standards and Interpretations Requests.~~

- Enhance the Request Numbering system to identify status of a given Request within the standards development process. ~~Enhancements to Request Numbering system to identify status of a given Request within the standards development process.~~

~~One of the premises to the Expanded Requests Logs is the ability to easily identify the status of ~~the a~~ request during ~~the its~~ processing ~~of it~~ from ~~the time it is~~ submitted ~~submission to the point at which it is published~~ publication in a version of the standards. Prior to a recommendation on a request being acted upon by the EC, the status ~~is would be~~ reflected through an indicator ~~of identifying~~ the subcommittee in which it is being processed. Once the request recommendation is acted upon by the EC, ~~a system is being recommended to add~~ a moniker *would be added* at the end of the request number. *This would be used to track that tracks* the status of the recommendation thereafter ~~which will indicate if~~ indicating whether the recommendation ~~has had~~ been approved by the EC (~~as including possibly possible modified~~ modification by the EC), declined, or failed. ~~After that, t~~The moniker ~~will would be updated~~ *change* to reflect ~~the its~~ status in the publication process.~~

- Append the 'As Approved' Recommendation Forms to the EC meeting minutes.
~~Appending the 'As Approved' Recommendation Forms to the EC meeting minutes.~~

*At various times, the EC ~~has made~~ makes modifications to ~~the~~ recommendations ~~that is~~ presented to it. In order to ensure agreement as to the final outcome of the EC action, it is recommended that the final results ~~are be attachments attached~~ to the draft / final minutes for ~~the subject~~ that EC meeting. The attachments would be approved ~~As as~~ a part of the approval of the draft minutes, ~~the attachments would be approved. In no way is it~~ The meeting minutes approval process ~~his~~ would not be an opportunity to change the standards but merely *the opportunity* to make administrative corrections to the final results. Subsequent to such approval, the member ratification would occur.*

- Expedite preparation of Meeting Minutes.~~Expedited Preparation of Meeting Minutes~~

In order to expedite member ratifications and eliminate time delays, especially towards publication deadline, ~~it is necessary for the above process to be handled~~ the draft meeting minutes should be made available ~~expeditiously~~ with a minimum of delay. ~~It is important for the~~ The draft minutes and attachments for each Executive Committee meeting ~~to~~ should be issued within 10 business days after the EC meeting. This will provide sufficient time for ~~these~~ review of the documentation. It is recognized that preparation of draft meeting minutes utilizes meeting transcripts. It will be critical to ensure timely receipt of the transcripts from the transcription service.

- Starting with the July 31, 2002 publication, modify the format and availability of the Contracts Standards manual to be more consistent with other Standards Manuals.

~~Starting with the July 31, 2002 publication, the format and availability of Contracts Standards manual more consistent with other Standards Manuals~~

Historically the Contracts Models and Standards have been some of the most successful products of the organization. The individual contracts are available on the Website and the CD, but not in the same manual format as the other standards. To avoid an appearance of inconsistency in presentation of the standards and related information, the Contracts Models and Standards should be compiled, formatted, and published in a manner more consistent with the other Standards Manuals. By making the Contracts available in the same format and location as the other Standards Manuals, the visibility and potential use of these standards will be enhanced.

Consistency & Higher Visibility

- Make the creation of printed Standards Manuals and CDs a post-publication process.

~~Creation of printed Standards Manuals and CDs should be a post-publication process.~~

The time between the last EC meeting at which standards votes can take place for recommendations to be included in the next version of the standards manuals and the publication date can be shortened by 20 days ~~time saving~~ if printed versions of the Standards Manuals and CDs containing the manuals are made available following the publication date. Since publication of the first version of Standards Manuals, internet web access has become common within the energy industry. Once the Standards Manuals are posted to the NAESB web site, they become available for download and printing to all NAESB members.

While the NAESB office does still receive requests for printed materials and CDs, these requests have become less frequent and are not time dependent for implementation purposes. Because the CDs are mass-produced, a fair amount of lead-time is necessary if they are to be included as a publication deliverable. The PPRTF recommends that CDs and printed materials still be made available from NASEB but does not believe that if they

are made available 20 days following the formal publication date that any parties will be significantly disadvantaged.

- Publish the next set of Standards Manuals as NAESB - Wholesale Gas Quadrant Version 1.6
~~The next set of Standards Manuals should be published as NAESB – Wholesale Gas Quadrant Version 1.6~~

~~Since other quadrants will not have had a chance to ratify standards or model business practices, the version to be published July 31, 2002 will be a NAESB - Wholesale Gas Quadrant publication. While the PPRTF has discussed whether a change in format or a significant event should be the catalyst for moving to a new version, i.e. Version 2.0, it has not reached any conclusions. At this point, the general consensus is that the versioning questioned should be deferred until other Quadrants have ratified Standards and/or Model Business Practices and their input can be incorporated.~~

- Refer to all Clarifications & Interpretations (e.g., Requests & Recommendations) as 'Interpretations'.
~~All Clarifications & Interpretations (e.g., Requests & Recommendations) should only be referred to as 'Interpretations'.~~

~~The use of the word 'clarification' in both Minor Clarifications & Corrections and the Clarifications/Interpretations has created confusion. To alleviate this confusion, it is recommended that the sole term 'all Clarifications & Interpretations' be utilized to refer to items that have historically been (e.g., Requests & Recommendations) should only be referred to as 'Clarifications/Interpretations'. This is the convention already used this way in the Standards Manuals.~~

- Conduct more frequent Ratification Votes
~~More frequent Ratification Votes~~

~~The general~~ Generally, the past practice of the GISB office has been to send ratification ballots to the membership after every other EC meeting. When the EC met every month, this resulted in bi-monthly ratification ~~meant more frequent~~ ballots. In more recent years, the EC has met every other month. Further, standards votes did not take place at every meeting resulting in ~~so~~ what appeared to be more erratic timing of ratification votes resulted.

The ratification vote is the last key event to occur prior to incorporation of changes to the ~~standards~~ Standards manuals Manuals. Historically, ratification ballots have never resulted in any rejected standards ~~so therefore~~ there is some validity to beginning publication work prior to completion of the vote. Never the less, if this practice is followed, ~~but~~ there is ~~always~~ the risk that work effort could be wasted upon a rejected standard.

- Move to a "Continuous" publication process.

Past publication efforts have been more "batch" oriented, i.e., the entire batch of standards ratified since the last publication ~~has been~~ was handed off to the publication team (which included contract technical writers) as one of the initial steps in preparation of the ~~standards~~ Standards manuals Manuals. This has lessened the impact of infrequent ratification votes. The PPRTF recommends that the publication preparation becomes a "continuous" process with the general thought that if work is broken into smaller batches, it is less prone to ~~minor~~ errors.

~~Further,~~ With more frequent ratification ballots, the corresponding modifications to the Standards could be processed as they are ratified instead of batching them into one large effort. ~~the work papers supporting more frequent ratification ballots~~ This would provide for

~~a are likely to be voluminous meaning that a~~ more thorough review of publication input materials as they are prepared for incorporation into the Standards Manuals ~~could occur~~. This ~~should~~ would also provide an opportunity to ~~theoretically~~ catch ~~any~~ upstream errors that ~~would~~ might not otherwise be caught during the publication process due to the magnitude of the number of changes being made.

Narrative explaining Open Issues

- Should there be a universal request numbering system for all quadrants?

Requests are currently assigned sequential numbers and historically have all pertained to Gas Wholesale. Prospectively, requests will be assigned to one or more quadrants. This, from the perspective of any one given quadrant, will create gaps in the numbering sequence which could appear confusing. Alternatively, a universal request numbering system for all quadrants could be less confusing if some accommodation to identify the applicable quadrant(s) is present. The PPRTF believes this issue is best addressed when quadrants are functioning and their input can be incorporated. ~~and begin to receive requests.~~

- Should there be a universal standards/model business practices numbering system?
If so, how are quadrant(s) specific standards indicated?

The current Standards numbering convention (x.y.z) has no accommodation for Standards other than those applicable to gGas ~~w~~Wholesale. Prospectively, Standards / Model Business Practices will be developed that will apply to one or more quadrants. Further, it is anticipated that some existing gGas ~~w~~Wholesale standards will be adopted by other quadrants. This, from the perspective of any one given quadrant, will create gaps in the numbering sequence which could appear confusing. Alternatively, a universal Standards numbering convention for all quadrants could be less confusing if some accommodation to identify the applicable quadrant(s) is present. The PPRTF believes this issue is best addressed when quadrants are functioning and their input can be incorporated. ~~and begin to receive requests.~~

- Should there be a separate standards/model business practices publication for each quadrant?
If so, should all quadrant publications be issued on the same date?

Prospectively, Standards / Model Business Practices will be developed that will apply to one or more quadrants. Further, it is anticipated that some existing gGas ~~w~~Wholesale standards will be adopted by other quadrants. While the answer to this question / issue may impact the answer to the universal Standards numbering convention question / issue above, having separate Standards / Model Business Practices publications creates the potential for identical standards being published by different quadrants with different identification numbers.

With four quadrants, staggering publication of individual quadrant Standards / Model Business Practices publications on a quarterly basis seems conceptually appealing in terms of distributing the workload throughout the year. -The logic favoring July 31 publication, however, should pertain to all quadrants. In this case, quadrants that publish on non-July 31 dates could be disadvantaged. Additionally, to the extent a given standard is applicable to more than one quadrant, with staggered publication dates, the standard would not be initially published for all users simultaneously. The PPRTF

believes this issue is best addressed when quadrants are functioning and their input can be incorporated.. ~~and begin to receive requests.~~

- Development of criteria for versioning of NAESB Standards Manuals.

While the PPRTF has discussed whether a change in format or a significant event should be the catalyst for moving to a new version, i.e. Version 2.0, it has not reached any conclusions. There is some thought that if the first set of Standards Manuals is published as NAESB Version 1.0, there could be some confusion with prior versions of the GISB Standards Manuals. At this point, the general consensus is that the versioning question should be deferred until other Quadrants have ratified Standards ~~and/or~~ / Model Business Practices and their input can be incorporated.

—Appendices

Appendix A) Publication References contained within the GISBOPs

Procedures for Communications with the FERC dated August 18, 1997.

4.0 PUBLICATION SCHEDULE FOR STANDARDS

a. The standards manuals and standards booklets shall be updated and new versions published no more than twice per year.

b. In the interim period between publication of standards manuals, it is recognized that, the following documents will be sent to the Secretary of the FERC no more than six times per year:

- 1) Final Standards Actions and member ratified voting record
- 2) Final Interpretations and member ratified voting record
- 3) Standards Request Log
- 4) Clarifications Log

Procedures for Standards Development and Maintenance dated August 18, 1997.

4.0 RESULTS – (last two sentences at the bottom of page 3)

Member ratified actions will be posted on the Final Action page of the GISB Home Page. Two times per year these actions will be incorporated into the implementation manuals.

Procedures for Adopting Standards dated August 18, 1997.

4.0 PUBLICATION OF STANDARDS

Following approval of a standards proposal by GISB Members, the Executive Director shall publish and issue it as either a new standard, an amendment to an existing standard or a new edition of an existing standard, as appropriate.

**Appendix B) Existing Recommendation Processing
Flowchart and Accompanying Notes**

(Standards Adoption by EC through Final Actions)

FINAL: 03/15/02

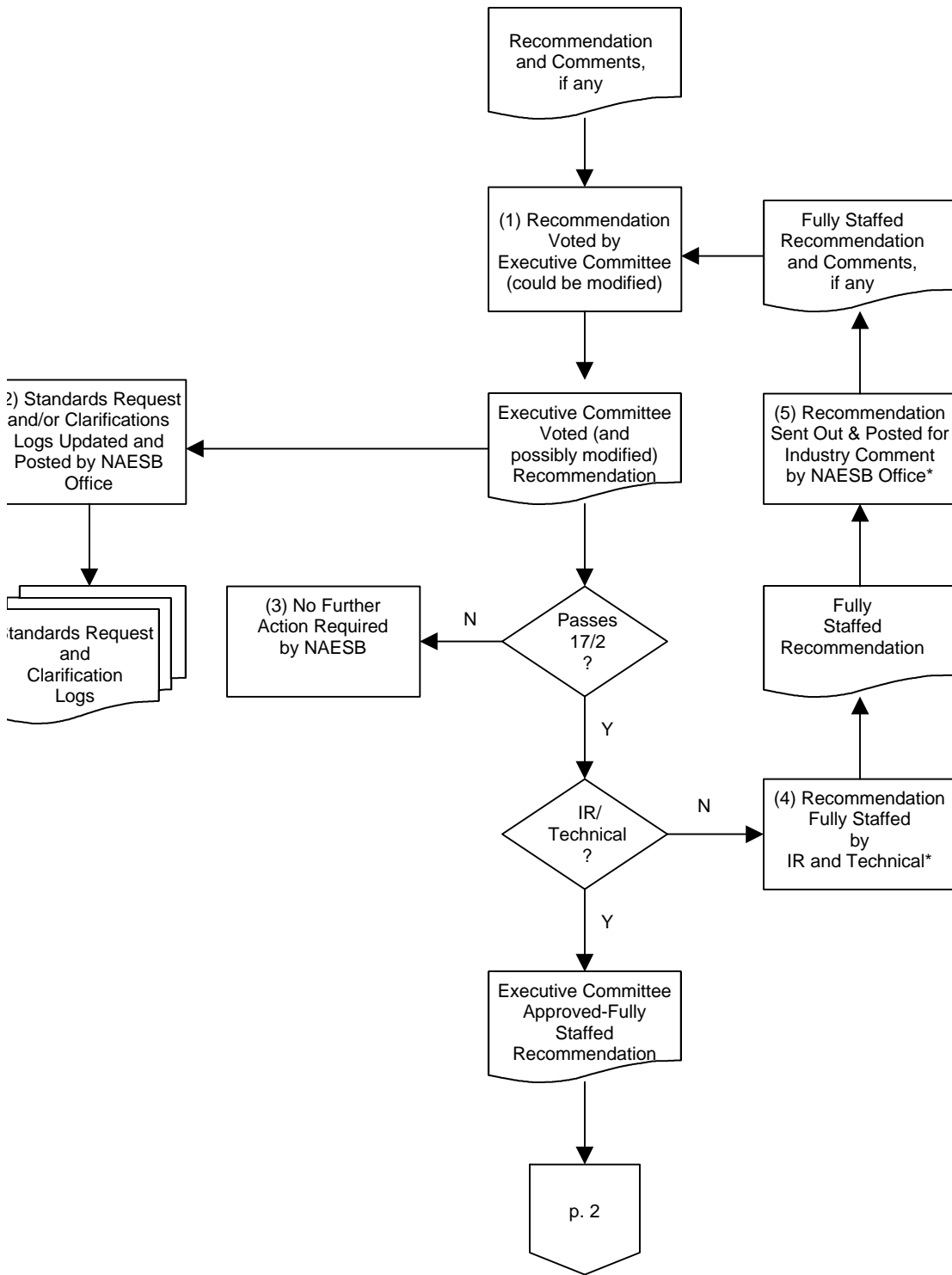

*The standards and/or clarification logs are updated and posted to reflect this process (see Process 2 and its resulting documents).

Legend:



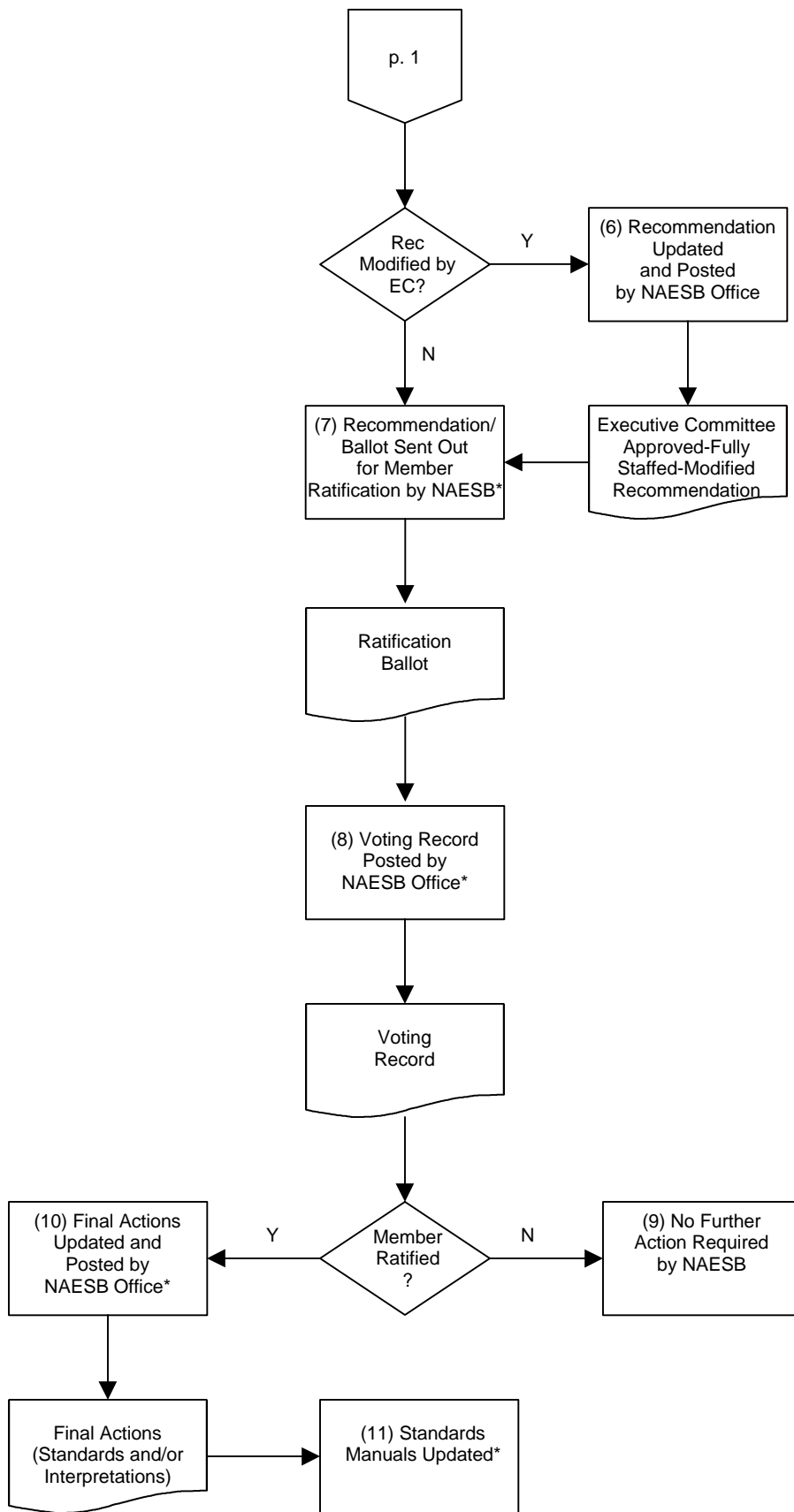

**Existing Recommendation Processing
(Standards Adoption by EC through Final Actions)**

FINAL: 03/12/02

1. A request recommendation and its comments, if any, are presented to the Executive Committee (EC) for a vote. The EC discusses and possibly modifies the recommendation and then takes a 17/2 vote on the recommendation.
2. The Standards Request Log and/or Clarifications Log are updated to reflect the results of the EC 17/2 and procedural votes. The updated logs are posted by the NAESB Office on the NAESB Web site.
3. If the recommendation fails the EC 17/2 vote, no further action is necessary by NAESB.
4. If the recommendation passes the EC 17/2 vote, and it is has not been processed by Information Requirements (IR) and Technical Subcommittees, it is sent to those subcommittees where the completion of the work (fully staffed) occurs. When completed, the chair of the Technical Subcommittee sends the fully staffed recommendation to the NAESB Office. The Standards Request and/or Clarification logs are updated and posted to reflect this process (See Process 2 and its resulting documents).
5. The NAESB Office posts the fully staffed recommendation on the NAESB Web site and sends out a request for industry comment for a period of time as specified in the GISB Operating Practices (GISBOPs). The Standards Request and/or Clarification logs are updated and posted to reflect this process (See Process 2 and its resulting documents).
6. If the EC approved-fully staffed recommendation was modified by the EC, the NAESB Office updates the recommendation and posts it, in addition to the previously posted recommendation(s) for that request, on the NAESB Web site.
7. The recommendation as approved by the EC and the corresponding ballot is sent out by the NAESB Office for member ratification for a period of time as specified in the GISBOPs. The Standards Request and/or Clarification logs are updated and posted to reflect this process (See Process 2 and its resulting documents).
8. The Membership Ratification Voting Record is posted by the NAESB Office on the NAESB Web site. The Standards Request and/or Clarification logs are updated and posted to reflect this process (See Process 2 and its resulting documents).
9. If the recommendation fails the membership ratification, no further action is necessary by NAESB.
10. If the recommendation passes the membership ratification, the NAESB Office updates the Final Actions (Standards and/or Interpretations) and posts it on the NAESB Web site. The Standards Request and/or Clarification logs are updated and posted to reflect this process (See Process 2 and its resulting documents).
11. The Final Actions (Standards and/or Interpretations) are used to update the NAESB standards manuals. The Standards Request and/or Clarification logs are updated and posted to reflect this process (See Process 2 and its resulting documents).

Appendix C) NAESB Request Logs
Examples and Accompanying Notes

NAESB REQUEST LOG - STANDARDS – YYYY

CURRENT AS OF (DATE)

[Note for explanation purposes: **Blue** indicates links
request]

Red indicates there is a legend below

Green shows a hypothetically completed

REQUEST INFORMATION			STATUS	REQUEST PROCESSING		EC PROCESSING			FINAL PROCESSING		
REQ. NO.	DESCRIPTION	REQUESTER & DATE REC'D	SC / TF (GROUP)	PRIORITY	GROUP & MEETING DATE	COMMENT DUE DATE	EC ACTION DATE	EC ACTION	RATIFICATION BALLOT DUE / RESULTS	FINAL ACTION POSTED	STANDARD New (N) / Modified (M)
(1)	(2)	(3)	(4)	(5)	(6)	(7)	(8)	(9)	(10)	(11)	(12)
(Link to the request) R01001					<i>(Link to minutes for each of the meeting dates shown)</i>	(Link to request for comment)	(Link to minutes for the date)		(Link to ballot) / (Link to voting results)	(Link to Final Actions posted)	
R01001	Add Change Gas Transaction Points Terms data element to various Capacity Release data sets.	Enron (ETS) 1/24/01	7-VER 1.7	NB	TR 2/13/01 EC 2/22/01 BPS 3/15/01 BPS 3/29/01 IR 1/15/02 IR 2/12/02 TECH 2/21/02 EC 4/11/02 IR 5/14/02 TECH 6/4/02 EC 8/15/02 EC 10/10/02	4/02/02 8/05/02	2/22/01 4/11/02 8/15/02 8/31/02 10/10/02	IN XFER- BPS XFER-IR ONV PASS MIN- PASS	Ballot: 11/30/02 Results: PASS	12/15/02	5.3.200 (N) 5.4.55 (M) 5.4.56 (M) 5.4.62 (M)
R98031	Develop an EDI data set to allow Confirmation Parties to elect to "Confirm by Exception" as provided for in 1.2.11 and 1.3.22. This would be classified as a "new transaction."	Tennessee 10/6/98	9 - NFA	NB	EC 10/15/98 EIITF 11/04/98 IR 01/11/00 BPS 02/24/00 EC 06/15/00	5/30/00	10/15/98 06/15/00	IN XFER- EIITF DECLIN E	N/A	N/A	N/A
R01014	Add Payee Bank Name, Payee Bank Location and Payee Bank Reference Information data elements to both Invoices.	Williams 3/21/01	2-IR (INV)	CUR	TR 4/11/01 EC 4/19/01 BPS 5/24/01 BPS 7/12/01 IR		4/19/01	IN XFER- BPS			

REQUEST INFORMATION			STATUS	REQUEST PROCESSING		EC PROCESSING			FINAL PROCESSING		
REQ. NO.	DESCRIPTION	REQUESTER & DATE REC'D	SC / TF (GROUP)	PRIORITY	GROUP & MEETING DATE	COMMENT DUE DATE	EC ACTION DATE	EC ACTION	RATIFICATION BALLOT DUE / RESULTS	FINAL ACTION POSTED	STANDARD New (N) / Modified (M)
(1)	(2)	(3)	(4)	(5)	(6)	(7)	(8)	(9)	(10)	(11)	(12)
R01015	Add Reduction Reason code values to the Confirmation Response, Scheduled Quantity and Scheduled Quantity for Operator.	Enron (ETS) 5/10/01	8-W/D	NB	TR 6/8/01 EC 6/14/01 BPS 6/21/01		6/14/01	IN XFER-BPS	N/A	N/A	N/A

NAESB REQUEST LOG – INTERPRETATIONS – YYYY

CURRENT AS OF (DATE)

[Note for explanation purposes: **Blue indicates links** **Red indicates there is a legend below** **Green shows a hypothetically completed request**]

REQUEST INFORMATION			STATUS	REQUEST PROCESSING		EC PROCESSING			FINAL PROCESSING		
REQ. NO.	DESCRIPTION	REQUESTER & DATE REC'D	SC / TF (GROUP)	PRIORITY	GROUP & MEETING DATE	COMMENT DUE DATE	EC ACTION DATE	EC ACTION	RATIFICATION BALLOT DUE / RESULTS	FINAL ACTION POSTED	STANDARD New (N) / Modified (M)
(1)	(2)	(3)	(4)	(5)	(6)	(7)	(8)	(9)	(10)	(11)	(12)
(Link to the request)					<i>(Link to minutes for each of the meeting dates shown)</i>	(Link to request for comment)	(Link to minutes for the date)		(Link to ballot) / (Link to voting results)	(Link to Final Actions posted)	
C00001	Calculation of Fuel for Pathed Non-threaded - should it be based on gross receipts or delivered volumes?	Hatch 1/05/01	7-VER 1.5	NB	IS 2/4/00 IS 5/26/00 EC 8/24/00 EC 10/24/00	8/04/00	8/24/00 10/24/00	PASS MIN-PASS	Ballot: 11/20/00 Results: PASS	2/25/01	7.3.85 (N)

NAESB REQUEST LOG - MINOR CLARIFICATIONS AND CORRECTIONS – YYYY

CURRENT AS OF (DATE)

[Note for explanation purposes: **Blue indicates links** **Red indicates there is a legend below** **Green shows a hypothetically completed request**]

REQUEST INFORMATION			STATUS	REQUEST PROCESSING		EC PROCESSING			FINAL PROCESSING		
REQ. NO.	DESCRIPTION	REQUESTER & DATE REC'D	SC / TF (GROUP)	PRIORITY	GROUP & MEETING DATE	COMMENT DUE DATE	EC ACTION DATE	EC ACTION	RATIFICATION BALLOT DUE / RESULTS	FINAL ACTION POSTED	STANDARD New (N) / Modified (M)
(1)	(2)	(3)	(4)	(5)	(6)	(7)	(8)	(9)	(10)	(11)	(12)
(Link to the request)					<i>(Link to minutes for each of the meeting dates shown)</i>	(Link to request for comment)	(Link to minutes for the date)		(Link to ballot) / (Link to voting results)	(Link to Final Actions posted)	
M02005	In Standard 3.4.87, for the data element Charge Type, the code value 'Capacity Constraint 'Crede' should be 'Capacity Constraint Credit'.	XYZ Pipeline	7-VER 1.7	NB	EC 9/14/02 EC 11/14/02	12/14/02	9/14/02 11/14/02	PASS MIN- PASS	N/A	12/21/02	3.4.87 (M)

LEGEND

STATUS – SUBCOMMITTEE TASK FORCE (GROUP)

STATUS

1 - SC / TF (GROUP) Subcommittee or Task Force from the following lists:
Example: BPS (CR)

SUBCOMMITTEE / TASK FORCE

ACT	ANSI Compliance Team
APSC	Annual Plan Subcommittee
BPS	Business Practices Subcommittee
CCSC	Common Codes Subcommittee
CSC	Contracts Subcommittee
EIITF	EBB - Internet Implementation Task Force
EC	Executive Committee
FTTF	Future Technology Task Force
PSC	Process Subcommittee
IR	Information Requirements Subcommittee
ISC	Imbalance Subcommittee
IS	Interpretation Subcommittee
TECH	Technical Subcommittee (was Task Force)
TR	Triage
XML	XML Subcommittee (under EDM Subcommittee)

(GROUP)

(CR)	Capacity Release related
(EDM)	Electronic Delivery Mechanism related
(FG)	Flowing Gas related
(GEN)	General
(INV)	Invoicing related
(K)	Contracts related
(NOM)	Nomination related
(O637)	Order 637

2-OIC	Out for Industry Comment
3-ECAopt	EC Adopted / Pending 'ECA' / 'MCA' Recommendation Procedural Approval
4-ECA Rec	'ECA' Recommendation Procedurally Approved / Pending Member Ratification
5-MR	Member Ratified / Pending Publication
6-MCAC	Completed Minor Clarifications and Corrections / Pending Publication
7-VER X.X	Publication Version
8-W/D	Withdrawn
9-NFA	No further action

PRIORITY

(Note: can be more than one – Example: Cur – hi = address it in the current round of business and make it the highest priority with those items in the round)

CUR	Current Round of Business (include it in the Group currently being addressed)
NB	Normal Course of Business
HI	High priority
LO	Low Priority

EC ACTION:

DECLINE	Affirmative Procedural Vote to Decline Request
FAIL	Failed the 17/2 Vote of the EC
IN	In Scope
MIN-PASS	'ECA'/'MCA' Attachment to EC Minutes Approved
ONV	Out for Notational Vote
OPV-FAIL	Other Procedural Vote Failed
OPV-PASS	Other Procedural Vote Passed
OUT	Out of Scope
PASS	Passed the 17/2 vote of the EC
POSTPN	Postponed for later consideration
TABLE	Item tabled by the EC
XFER	Transfer to Subcommittee (include Subcommittee or Task Force)

Proposed NAESB Request Logs
FINAL: 03/15/02

Column 1: Request No.

The request number assigned by the NAESB office. There is a link from each request number to the corresponding actual request posted on the appropriate page as follows:

- Requests for Standards
- Clarification Requests or
- Minor Clarifications and Corrections.

Column 2: Description

Brief description of the request.

Column 3: Requester & Date Rec'd

The name of the party submitting the request and the date it was received by the NAESB office.

Column 4: SC/TF (Group)

This column provides several pieces of information.

- The status is a numerical code representing the location of the request in the NAESB process.
- SC/TF – indicates the subcommittee or task force where the request currently resides.
- (Group) – the category / topic of the request. This information is deleted when the recommendation is available for industry comment.

Refer to legend for the complete listing of code values for each of these items.

Column 5: Priority

The priority assigned to the request by the Executive Committee. Refer to legend for the complete listing of code values for this item.

Column 6: Group and Meeting Date

For all of the SC/TF (Group) meetings where the item is discussed, the name of the group and the date of each meeting. This includes all EC meetings. This is a comprehensive list that is updated throughout the processing of the request so that users have the ability to see the historical path of the request. Each date is a link to the corresponding meeting minutes posted on the NAESB Web site.

Anytime the EC meets and discusses a request, the dates and actions are further delineated in columns 8 and 9.

Column 7: Comment Due Date

The date when comments are due to the NAESB office. The date is a link to the corresponding request for comments posted on the NAESB Web site. For Standards or Interpretations, the comment due date is prior to the EC meeting where the corresponding recommendation is acted upon. For Minor Clarifications and Corrections, the comment due date is after the EC has approved the recommendation.

Column 8: EC Action Date

The date on which the EC took any and all actions on the request, not limited to a 17/2 vote. Each date is a link to the corresponding meeting minutes posted on the NAESB Web site.

Column 9: EC Action

All EC actions are recorded. This is a comprehensive list that is updated throughout the processing of the request so that users have the ability to see the historical path of the request. Refer to legend for the complete listing of code values for this item.

Column 10: Ratification Ballot Due / Results

The date when member ratification ballots are due to the NAESB office. The date is a link to the corresponding ratification ballot on the NAESB Web site. The indicated results of the vote are a link to the voting record posted on the NAESB Web site. Minor Clarifications and Corrections are not subject to member ratification.

Column 11: Final Action Posted

The date when the MR / MCAC Recommendation is posted to the Final Actions on the NAESB Web site. The date is a link to such MR / MCAC Recommendation.

Column 12: Standard New (N) / Modified (M)

The number of the new or modified standard(s) or clarification(s) contained in the MR / MCAC Recommendation.

**Appendix D) Minor Clarifications and Corrections Processing
Flowchart and Accompanying Notes**

Flow Chart of Proposed Minor Clarifications and Corrections Recommendation Processing

FINAL: 03/15/02

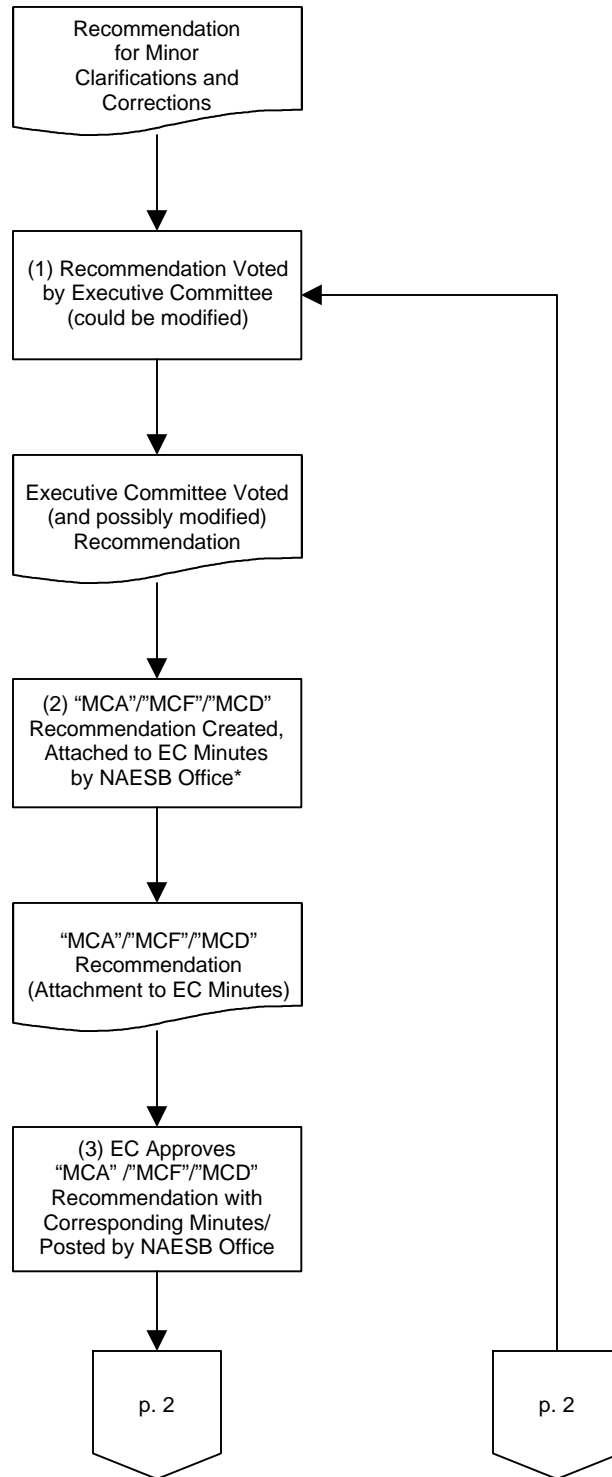

*The appropriate NAESB Request Log is updated and posted to reflect this process (see Process 4 and its resulting document).

Legend:

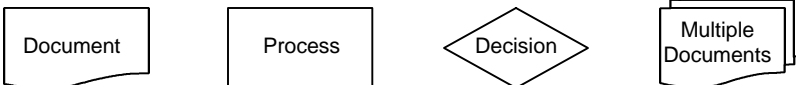

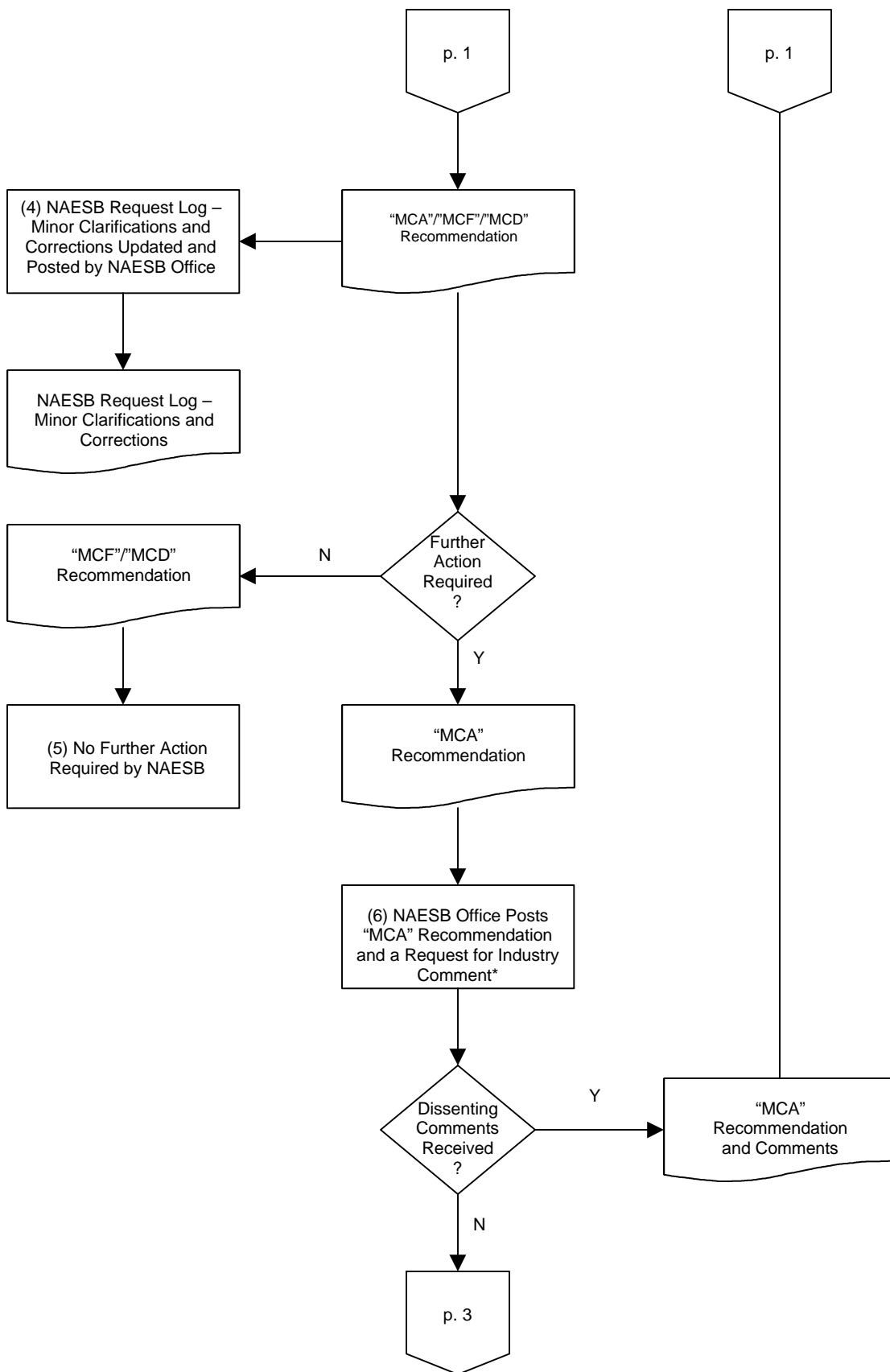

Flow Chart of Proposed Minor Clarifications and Corrections Recommendation Processing – p. 2

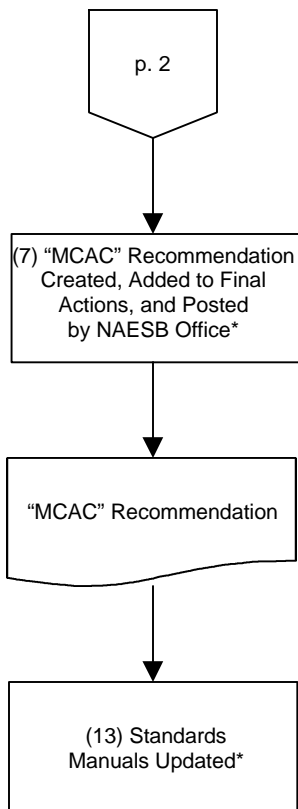

Proposed Minor Clarifications and Corrections Recommendation Processing

FINAL: 03/15/02

1. A Minor Clarification and Corrections Recommendation is presented to the Executive Committee (EC) for a vote. The EC discusses and possibly modifies the recommendation and then takes a procedural vote on the recommendation.
2. The NAESB Office creates a MCA/MCF/MCD Recommendation, which reflects the recommendation as approved by the EC.
 - MCA – EC approved the proposed recommendation (includes any modifications made by the EC);
 - MCF – EC did not approve the proposed recommendation; and
 - MCD – EC approved the proposed recommendation to decline the request.

The NAESB Office should create the MCA/MCF/MCD Recommendation by doing the following:

- take the recommendation and add the moniker at the end of the request number to show the EC action (MCA/MCF/MCD) and the date of the EC action. For example, if a recommendation for request M97001 is brought before the EC and approved by a procedural vote on 11/5/01, then the as approved recommendation is annotated as M97001-MCA-110501; and
- only include the contents of section 3 from the recommendation form as approved by the EC (inclusive of any modifications the EC might have made during the approval process). This should also include updating the 'Summary' section to reflect the EC's actions.

This document is posted as an attachment to the corresponding EC Minutes, both of which should be posted within seven business days of the EC meeting. The NAESB Request Log - Minor Clarifications and Corrections is updated and posted to reflect this process (see Process 4 and its resulting document).

3. By a procedural vote, as part of the EC review of the previous EC meeting minutes, the EC approves the MCA/MCF/MCD Recommendation. The MCA/MCF/MCD Recommendation is posted, in addition to the previously posted recommendation(s), on the NAESB Web site.
4. The NAESB Request Log - Minor Clarifications and Corrections is updated to reflect the results of the EC procedural vote. The updated log is posted by the NAESB Office on the NAESB Web site.
5. If it is an MCF or MCD Recommendation, no further action is necessary by NAESB.
6. The NAESB Office posts the MCA Recommendation on the NAESB Web site and posts a request for industry comment for a period of time as specified in the GISB Operating Practices (GISBOPs). The NAESB Request Log - Minor Clarifications and Corrections is updated and posted to reflect this process (see Process 4 and its resulting document).
 - If no dissenting comments are received, the MCA Recommendation is approved.
 - If dissenting comments are received, the MCA Recommendation is returned to the EC for further consideration (step 1). The NAESB Request Log - Minor Clarifications and Corrections is updated and posted to reflect this process (see Process 4 and its resulting document).

7. If the MCA Recommendation is approved, the NAESB Office updates the MCA Recommendation by modifying the moniker to reflect its completed status and the date of its completion (the Comment Due Date). Using the example in number 2 above, if M97001-MCA-110501 is subsequently completed on 02/05/02, it would be renamed M97001-MCAC-020502.

Within 7 business days of the Comment Due Date, the NAESB Office posts the MCAC Recommendation to the Final Actions and on the Request for Minor Clarifications and Corrections page on the NAESB Web site. The NAESB Request Log - Minor Clarifications and Corrections is updated and posted to reflect this process (see Process 4 and its resulting document).

8. The Final Actions are used to update the NAESB standards manuals, which should be published annually on July 31. Errata and corrections may be published as required. The NAESB Request Log - Minor Clarifications and Corrections is updated and posted to reflect this process (see Process 4 and its resulting document).

**Appendix E) Proposed Recommendation Processing
Flowchart and Accompanying Notes**

Flow Chart of Proposed Recommendation Processing (Standards Adoption by EC through Final Actions)

FINAL: 03/15/02

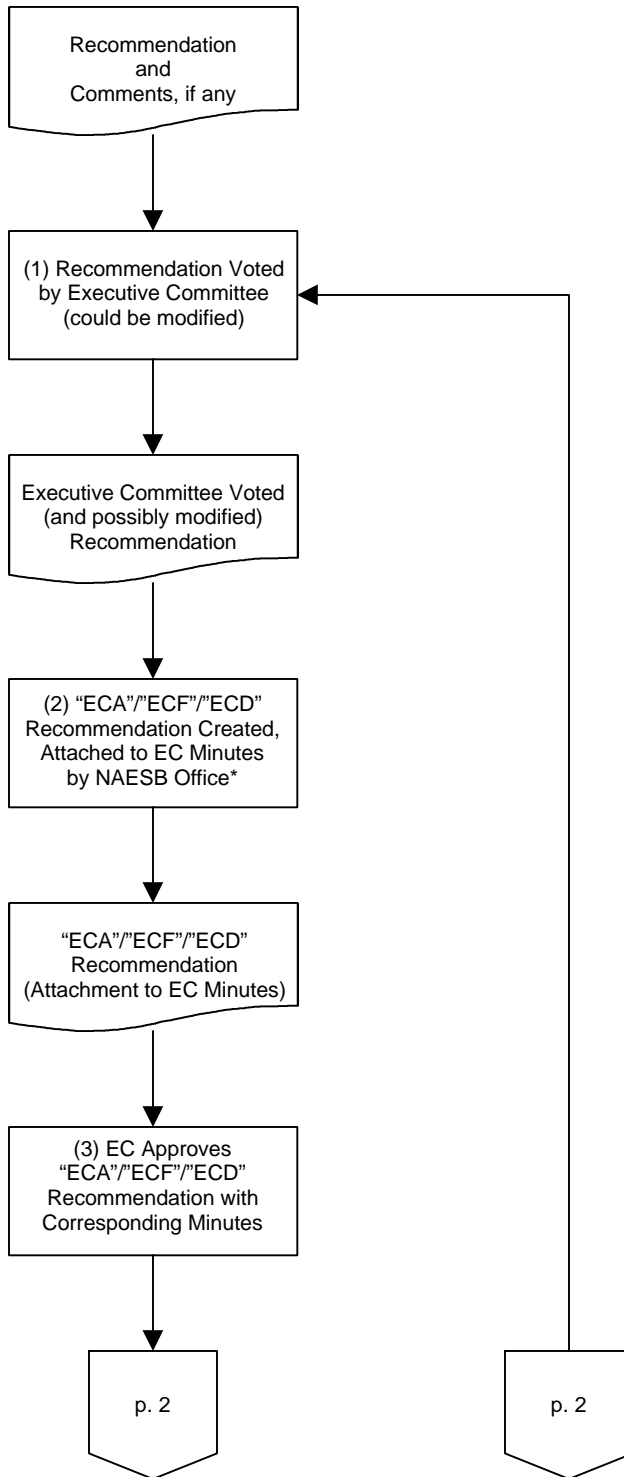

*The appropriate NAESB Request Log(s) are updated and posted to reflect this process (see Process 4 and its resulting documents).

Legend:

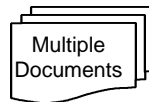
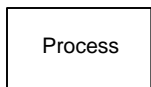
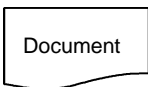

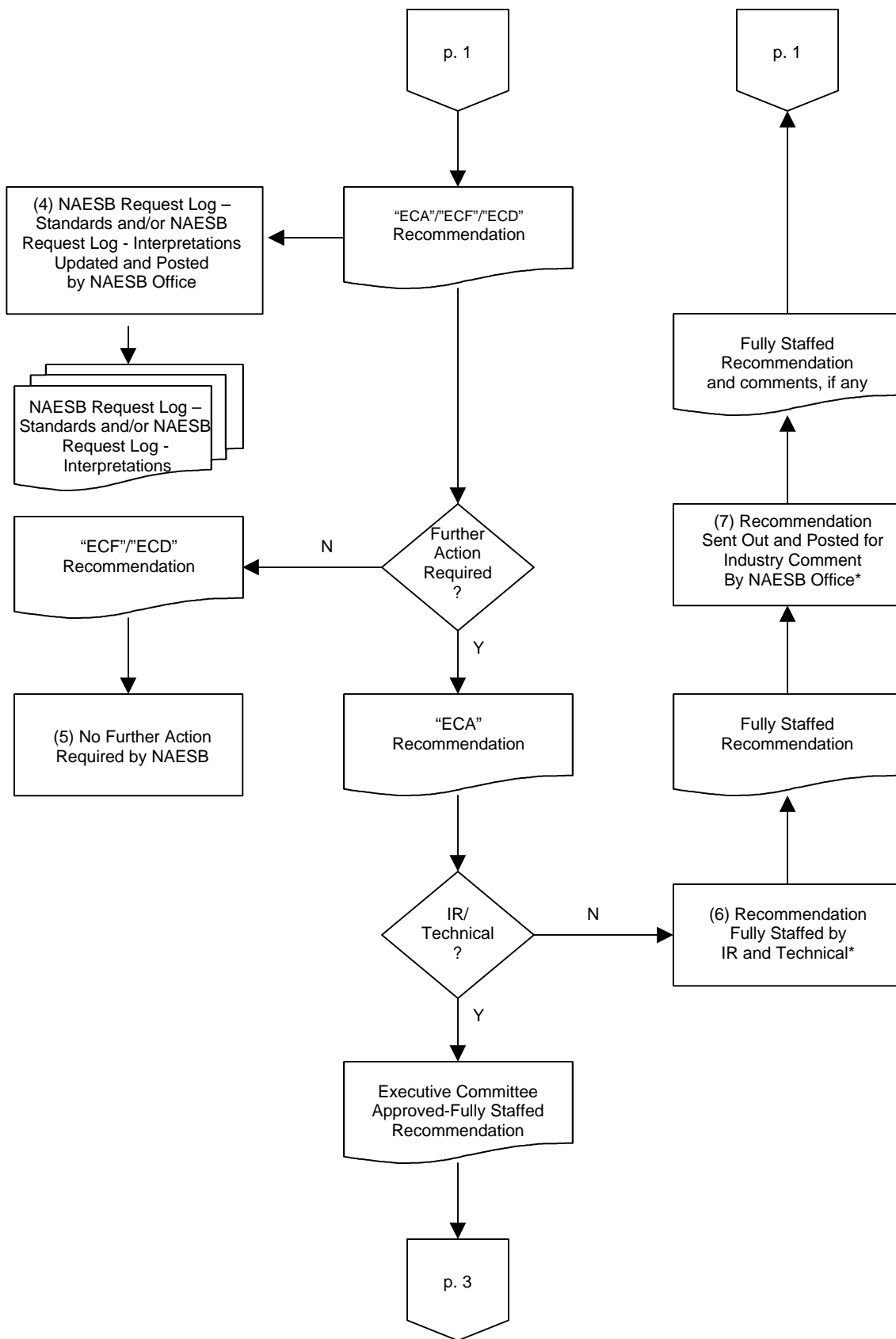

Flow Chart of Proposed Recommendation Processing – p. 2

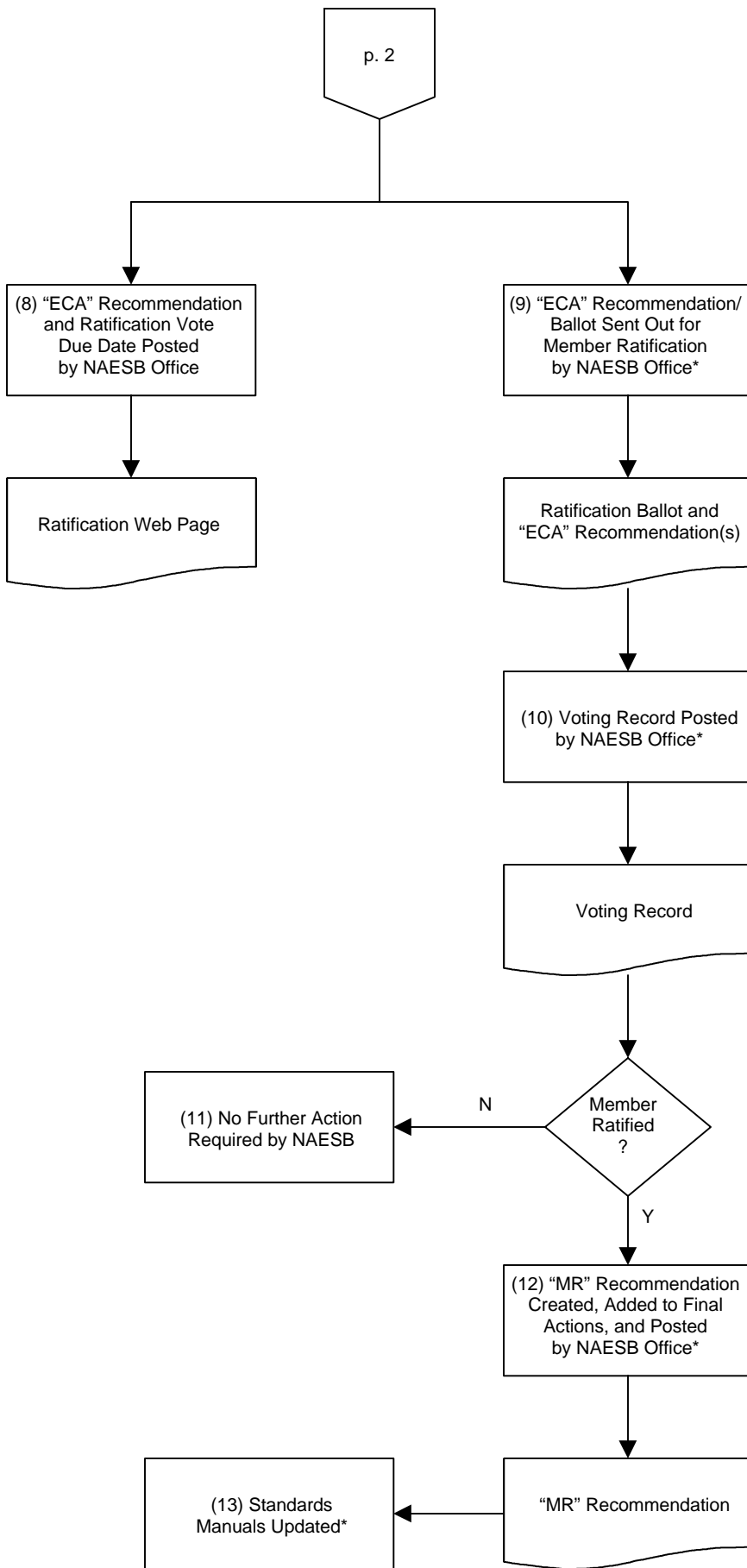

Flow Chart of Proposed Recommendation Processing – p. 3

**Proposed Recommendation Processing
(Standards Adoption by EC through Final Actions)**

FINAL: 03/15/02

1. A request recommendation and its comments, if any, are presented to the Executive Committee (EC) for a vote. The EC discusses and possibly modifies the recommendation and then takes a 17/2 or procedural vote, as appropriate, on the recommendation.
2. The NAESB Office creates an ECA/ECF/ECD Recommendation which reflects the recommendation as approved by the EC.
 - ECA – EC approved the proposed recommendation for standards (includes any modifications made by the EC);
 - ECF – EC did not approve the proposed recommendation for standards; and
 - ECD – EC approved the proposal to decline the request.

The NAESB Office should create the ECA/ECF/ECD Recommendation by doing the following:

- Add the moniker at the end of the request number to show the EC action (ECA/ECF/ECD) and the date of the EC action. For example, if a recommendation for request R97001 is brought before the EC and approved by a 17/2 vote on 11/5/01, then the as approved recommendation is annotated as R97001-ECA-110501; and
- only include the contents of section 3 from the recommendation form as approved by the EC (inclusive of any modifications the EC may have made during the approval process). This should also include updating the 'Summary' section to reflect the EC's actions.

This document is posted as an attachment to the corresponding EC Minutes, both of which should be posted within seven business days of the EC meeting. The appropriate NAESB Request Log(s) are updated and posted to reflect this process (See Process 4 and its resulting documents).

3. By a procedural vote, as part of the EC review of the previous EC meeting minutes, the EC approves the ECA/ECF/ECD Recommendation. The ECA/ECF/ECD Recommendation is posted on the Request for Standards or Clarification Request Page, as appropriate, in addition to the previously posted recommendation(s), on the NAESB Web site.
4. The NAESB Request Log – Standards and / or the NAESB Request Log – Interpretations are updated to reflect the results of the EC 17/2 and procedural votes. The updated logs are posted by the NAESB Office on the NAESB Web site.
5. For an ECF or ECD Recommendation, no further action is necessary by NAESB.
6. For an ECA Recommendation that has not been processed by Information Requirements (IR) and Technical Subcommittees, it is sent to those subcommittees where the completion of the work (fully staffed) occurs. The appropriate NAESB Request Log(s) are updated and posted to reflect this process (See Process 4 and its resulting documents).

When completed, the chair of the Technical Subcommittee sends the fully staffed recommendation to the NAESB Office no later than 12:00 p.m. (Central Clock Time) on the business day before the industry comment period is scheduled to begin.

7. The NAESB Office posts the fully staffed recommendation, in addition to the previously posted recommendation(s) on the Request for Standards or Clarification Request Page, as appropriate, on the NAESB Web site. The NAESB Office sends out a request for industry comment for a period of time as specified in the GISB Operating Practices (GISBOPs). The appropriate NAESB Request Log(s) are updated and posted to reflect this process (See Process 4 and its resulting documents).
8. The NAESB Office posts the ballot due date and the corresponding ECA Recommendation(s) on the NAESB Web site Ratification Page. The ratification due date is also reflected on the NAESB Calendar that is posted on the NAESB Web site.
9. The Member Ratification ballot and the corresponding ECA Recommendation(s) are sent out by the NAESB Office for member ratification within five business days of the approval of the ECA Recommendation for a period of time as specified in the GISBOPs. The appropriate NAESB Request Log(s) are updated and posted to reflect this process (See Process 4 and its resulting documents).
10. The Membership Ratification Voting Record is posted by the NAESB Office on the NAESB Web site within 3 business days of the ratification due date. The appropriate NAESB Request Log(s) are updated and posted to reflect this process (See Process 4 and its resulting documents).
11. If the ECA Recommendation fails the membership ratification, no further action is necessary by NAESB.
12. If the ECA Recommendation passes the membership ratification, the NAESB Office updates the ECA Recommendation by doing the following:
 - modify the moniker to reflect its ratified status and the date of the ratification. Using the example in #2 above, if R97001-ECA-110501 is subsequently member ratified on 1/15/02, it would then be referred to as R97001-MR-011502; and
 - incorporate, if appropriate, the new NAESB standard numbers.

Within 7 business days of the ratification due date, the NAESB Office posts the MR Recommendation to the Final Actions and on the Request for Standards or Clarification Request Page, as appropriate, on the NAESB Web site.

13. The Final Actions are used to update the NAESB standards manuals which should be published annually on July 31. Errata and corrections may be published as required. The appropriate NAESB Request Log(s) are updated and posted to reflect this process (See Process 4 and its resulting documents).

**Appendix F) Proposed Publication Process
Flowchart and Accompanying Notes
Timeline & Schedule**

(Final Actions through Publication)

FINAL: 03/15/02

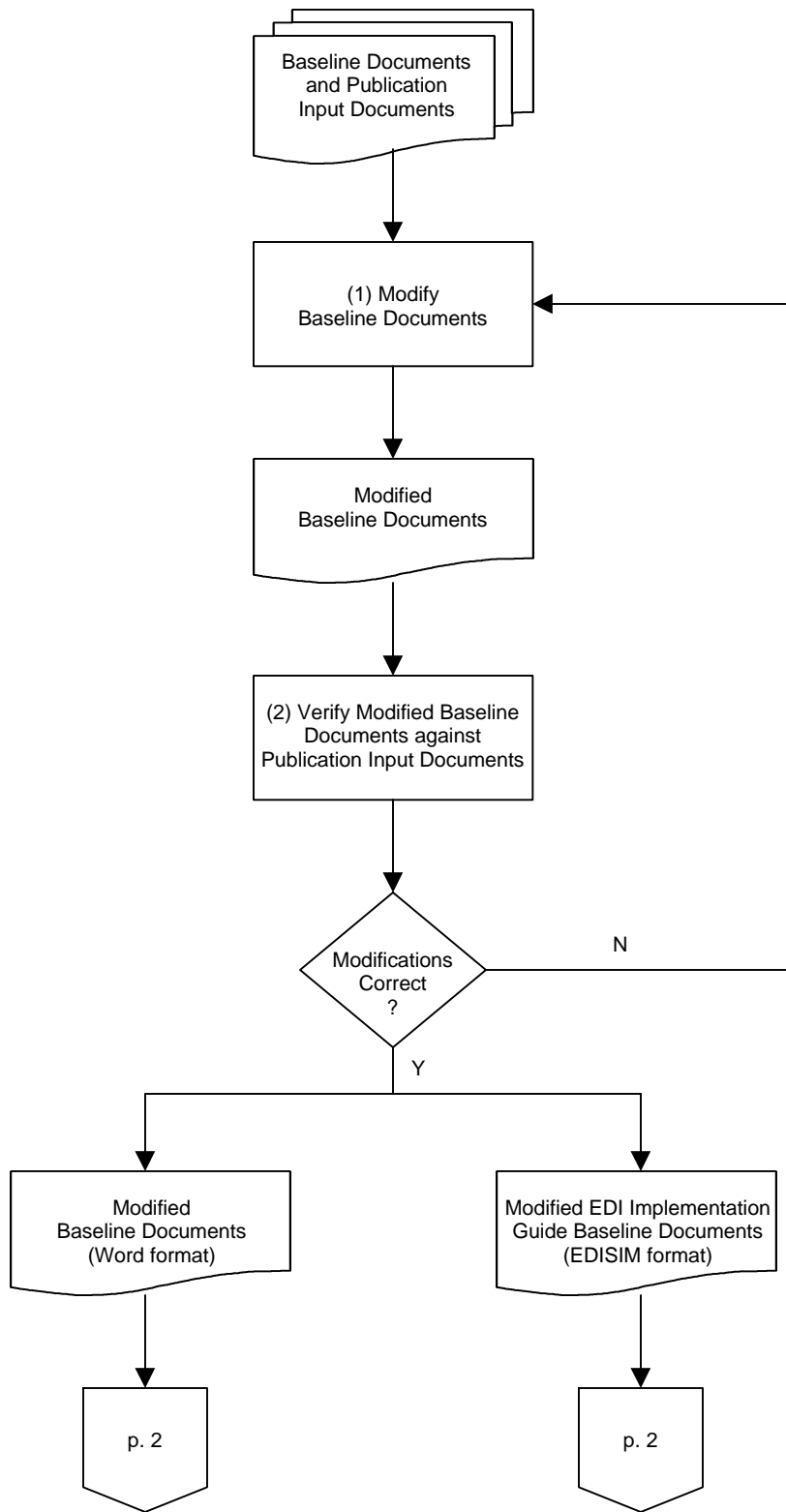

Legend:

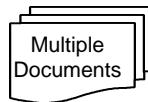
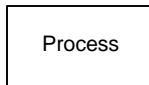
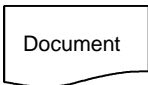

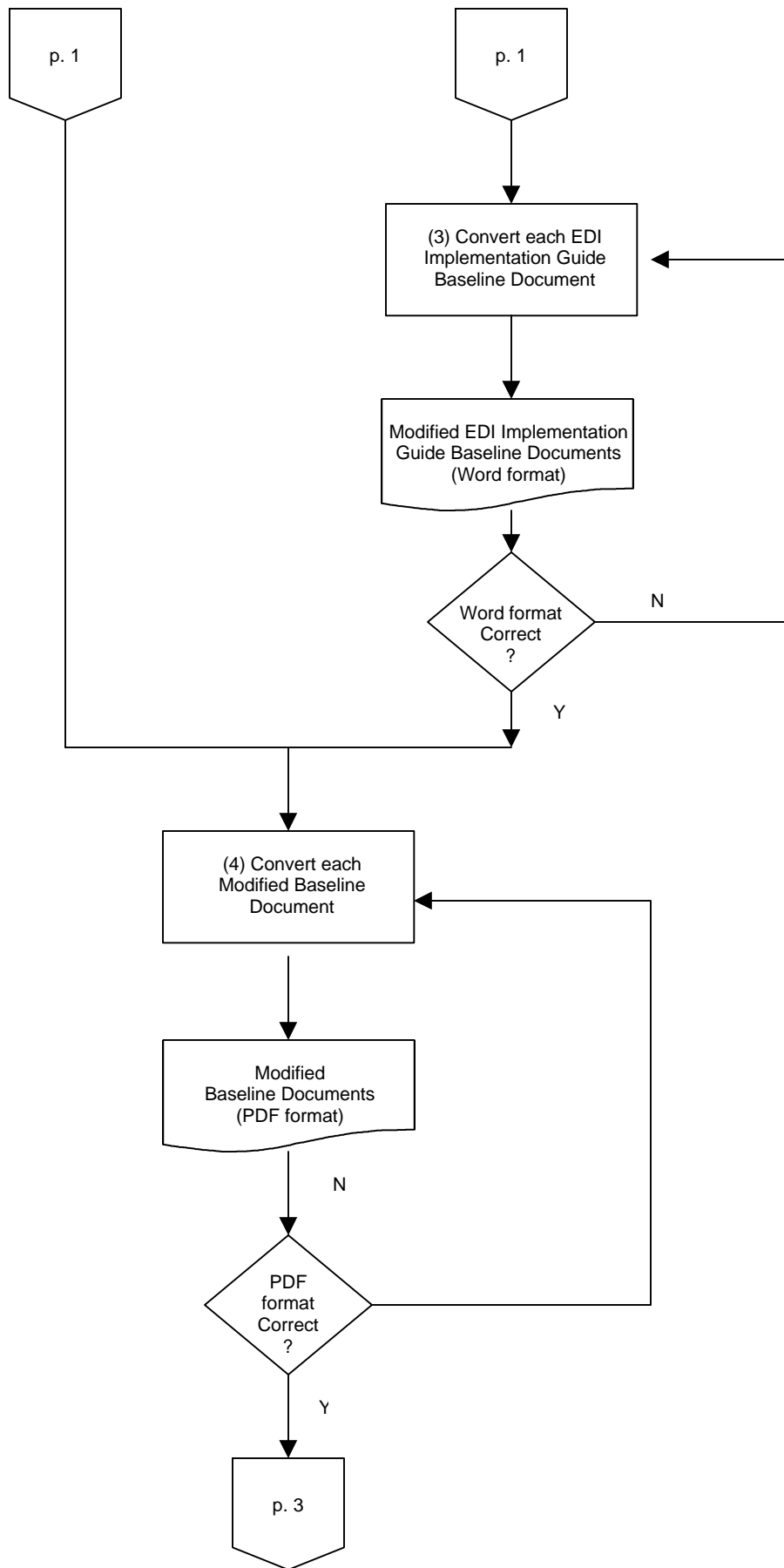

Flow Chart of Proposed Publication Process – p. 2

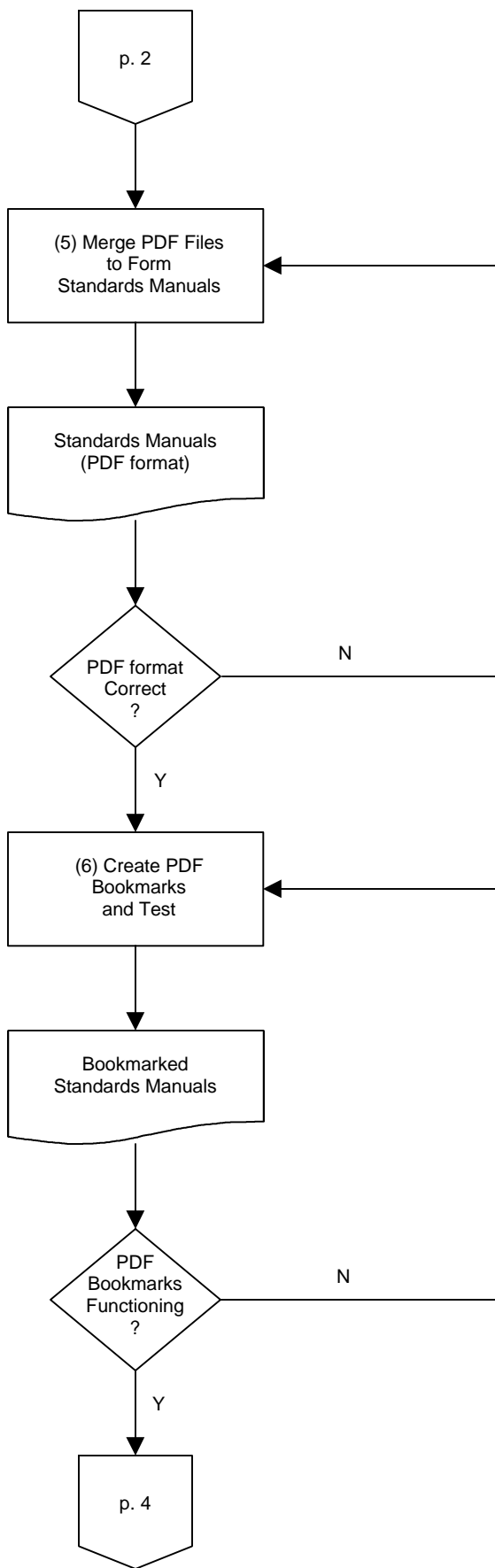

Flow Chart of Proposed Publication Process – p. 3

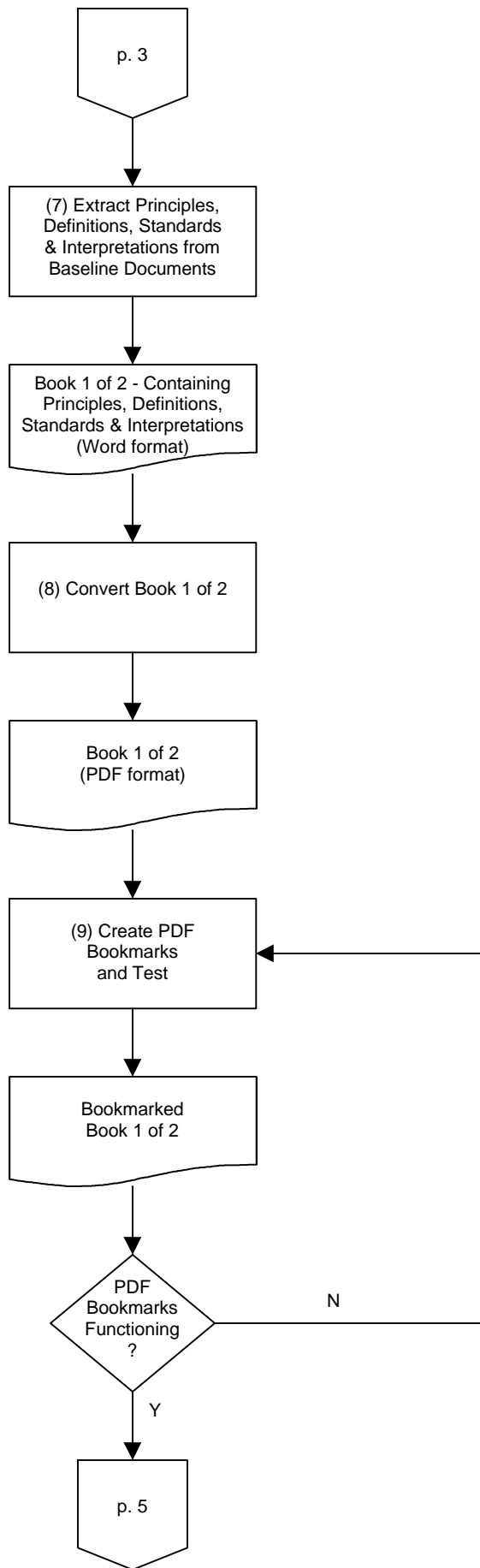

Flow Chart of Proposed Publication Process – p. 4

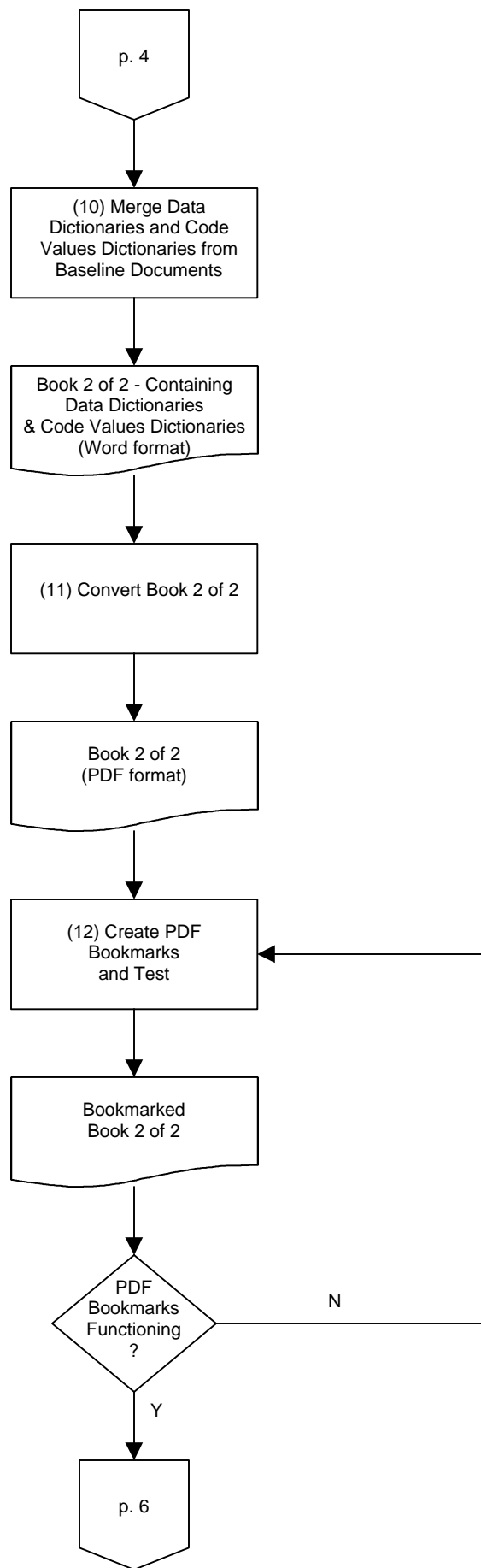

Flow Chart of Proposed Publication Process – p. 5

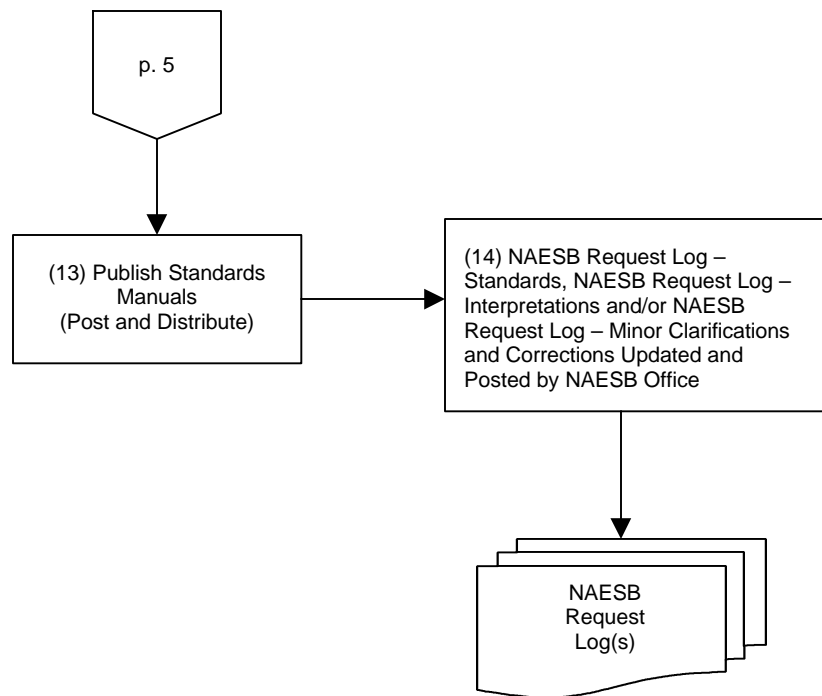

**Proposed Publication Process
(Final Actions through Publication)**

FINAL: 03/15/02

1. Use Publication Input Documents (MR Recommendations, MCAC Recommendations, Errata, and Technical Change Log) to make modifications to the following Baseline Documents, which comprise the Standards Manuals documents:

Standards Manuals: One file contained in all Books:
Related Standards

Standards Manuals: One file contained in Nominations, Flowing Gas, Invoicing, and Capacity Release:
Introduction

Standards Manuals: Nominations, Flowing Gas, Invoicing, and Capacity Release: Each of the listed manuals has its own unique version of the following files:

- Table of Contents
- Version Notes
- Executive Summary
- Business Process and Practices

Standards Manuals: Nominations, Flowing Gas, Invoicing, and Capacity Release: Each data set contained within each of the listed manuals includes its own unique version of the following files:

- Technical Implementation of the Business Process
- Sample Paper Transaction
- Data Dictionary
- Data Element Cross Reference to ASC X12
- Sample ASC X12 Transaction
- EDI Implementation Guide (EDISIM)
- Transaction Set Tables

Standards Manual: Electronic Delivery Mechanism (EDM)

- Table of Contents
- Version Notes
- Introduction
- Executive Summary
- Business Process and Practices
- Technical Implementation – Internet EDI/EDM and Batch FF/EDM
- Technical Implementation – Informational Postings Web Site
- Technical Implementation – EBB/EDM
- Technical Implementation – FF/EDM
- Appendices

Standards Manual: Contracts

- Table of Contents
- Version Notes
- Introduction
- Executive Summary
- Business Process and Practices
- Standards Contracts:
 - Base Contract for Sale and Purchase of Natural Gas
 - Day Trade Interruptible
 - Trading Partner Agreement

Model Contracts:
 Model Funds Transfer Agreement
 Model Operational Balancing Agreement
Sample Contracts

Summary Book 1 of 2 and Book 2 of 2
 Version Cross Reference and Interpretation Cross Reference

Summary Book 1 of 2
 Table of Contents

Summary Book 2 of 2
 Table of Contents

For each of the Baseline Documents pertaining to a given Standards Manual, changes contained in the Publication Input Documents should be made in chronological order. All files above, except the EDI Implementation Guide Baseline Documents, are updated using the Microsoft® Word product. The EDI Implementation Guide Baseline Documents are updated using FORESIGHT's® EDISIM product.

2. Verify modifications made to the Baseline Documents in step 1 above against the above listed Publication Input Documents. Also, “eyeball” formatting, such as fonts, margins, spacing, etc.
3. Each EDI Implementation Guide Baseline Document is first converted to RTF format and then imported into a Word file. This Word file is then modified to incorporate the same document formatting that is used in the rest of the Standards Manual.
4. All Word documents are converted to Adobe Acrobat PDF format. Each page is “eyeballed” for formatting issues. Note: Most formatting issues can be resolved by re-creating the PDF file.
5. The PDF files are then merged together to form the Standards Manuals. Each page is “eyeballed” for formatting issues.
6. Create PDF file Bookmarks. Proofread and test.
7. To begin creation of Summary Book 1 of 2, extract Principles, Definitions, Standards, and Interpretations from each of the modified Baseline Documents entitled Business Process and Practices created in steps 1 and 2 above (Word format) to create a single Word document. This includes merging in Table of Contents, Version Cross Reference and Interpretation Cross Reference.
8. The Word document is converted to Adobe Acrobat PDF format, creating Book 1 of 2. Each page is “eyeballed” for formatting issues. Note: Most formatting issues can be resolved by re-creating the PDF file.
9. Create PDF file Bookmarks. Proofread and test.
10. To begin creation of Summary Book 2 of 2, use Data Dictionaries and Code Values Dictionaries from each of the modified Baseline Documents created in steps 1 and 2 above (Word format) to create a single Word document containing all Data Dictionaries and Code Values Dictionaries. This includes merging in Table of Contents, Version Cross Reference and Interpretation Cross Reference.

11. The Word document is converted to Adobe Acrobat PDF format, creating Book 2 of 2. Each page is “eyeballed” for formatting issues. Note: Most formatting issues can be resolved by re-creating the PDF file.
12. Create PDF file Bookmarks. Proofread and test.
13. Publish Standards Manuals (Post and Distribute).
14. The NAESB Request Log(s), i.e. NAESB Request Log – Standards, NAESB Request Log – Interpretations and/or NAESB Request Log – Minor Clarifications and Corrections, are updated to reflect the standards publication version. The updated logs are posted by the NAESB Office on the NAESB Web site.

PROPOSED TIMELINE TABLE FOR PUBLICATION OF NAESB STANDARDS

FINAL: 03/15/02

Step	Duration	Cumulative Days	Event	Notes
1	1	1	Last EC Approved Recommendation Voted	This is the last date an EC meeting can be held during which a vote on fully staffed recommendations (standards and clarifications) that effect the next version.
2	10	11	EC Minutes prepared and adopted	This is the last date an EC meeting can be held to adopt minutes from the EC meeting in Step 1. It may be held by conference call.
3	23 ¹	34	Member Ratification	Can be shortened by EC if necessary. A 30-calendar day ratification period incorporates 20 working days.
4	30	44	Changes made to baseline ² documents and proofing	This step begins after completion of Step 2. If Step 3 (ratification) fails changes are omitted. This is an iterative process which may involve "volunteers" and others knowledgeable about specific content revisions. It includes proofing of content and format.
5	3	47	Prepare Standards Manuals in PDF format containing the documents from Step 4	This includes the compilation and bookmarking of the Standards Manuals.
6	2	49	Prepare Book 1 of 2 and Book 2 of 2 in PDF format containing the documents from Step 4	This includes the compilation and bookmarking of Book 1 of 2 and Book 2 of 2 (Summary Books).
7	3	52	Final Proofing	No content proofing takes place; this is a review of the print layout and is the last review of media preparation input materials.
8	3 ³	55 July 31	Publication Date	Revised Standards Manuals and Summary Books are available to members via PDF files posted on the NAESB Web site. It is the recommendation of the PPRTF that preparation of the printed materials and CDs be a post-publication process.

General Notes:

- Date refers to a duration of time with the exception of Step 8, which is a deadline. Each step presumes completion of the previous step, except where noted.
- All days, unless otherwise noted, are business/working days.
- Within each step above, specific timelines may be established for coordination of work.

Footnotes:

1. Assumes 3 days to prepare document for member ratification.
2. Baseline documents consist of the following

**Standards Manuals: One file contained in all Books:
Related Standards**

**Standards Manuals: One file contained in Nominations,
Flowing Gas, Invoicing, and Capacity Release:**

Introduction

**Standards Manuals: Nominations, Flowing Gas, Invoicing, and
Capacity Release: Each of the listed manuals has its own
unique version of the following files:**

Table of Contents
Version Notes
Executive Summary
Business Process and Practices

**Standards Manuals: Nominations, Flowing Gas, Invoicing, and
Capacity Release: Each data set contained within each of
the listed manuals includes its own unique version of the
following files:**

Technical Implementation of the Business Process
Sample Paper Transaction
Data Dictionary
Code Values Dictionary
Data Element Cross Reference to ASC X12
Sample ASC X12 Transaction
EDI Implementation Guide (EDISM)
Transaction Set Tables

**Standards Manual: Electronic Delivery Mechanism
(EDM)**

Table of Contents
Version Notes
Introduction

Executive Summary
Business Process and Practices
*Technical Implementation – Internet EDI/EDM and Batch
FF/EDM*
Technical Implementation – Informational Postings Web Site
Technical Implementation – EBB/EDM
Technical Implementation – FF/EDM
Appendices

Standards Manual: Contracts

Table of Contents
Version Notes
Introduction
Executive Summary
Business Process and Practices

Standard Contracts:

Base Contract for Sale and Purchase of Natural Gas
Day Trade Interruptible
Trading Partner Agreement

Model Contracts:

Model Funds Transfer Agreement
Model Operational Balancing Agreement

Sample Contracts

Summary Book 1 of 2 and Book 2 of 2

Version Cross Reference and Interpretation Cross Reference

Summary Book 1 of 2

Table of Contents

Summary Book 2 of 2

Table of Contents

3. If preparation of the printed materials and CDs is a pre-publication process, an additional step with a duration of 20 days will increase the number of cumulative days since the beginning of the publication process to 72 days. The preparation of the printed materials and CDs is an iterative exchange of materials between the NAESB office and the publication vendor(s) for quality control purposes